

PIR Application Guide for TB7200 and TB7300 Series Thermostats

APPLICATION GUIDE



**TB7300 Series
Thermostat with
Occupancy Sensor**

PRODUCT OVERVIEW

This application guide provides application information and for Honeywell TB7200 and TB7300 Series communicating thermostats. When equipped with an occupancy sensor cover or a remote PIR sensor (wired to one of the remote inputs), these thermostats provide advanced active occupancy logic, which automatically switches occupancy levels from Occupied to Stand-by to Unoccupied as required by local activity being present or not. TB7200 and TB7300 Series thermostats can be ordered with an occupancy sensor cover or have one added at a later time. All thermostats are PIR ready. The occupancy sensor covers have an embedded, passive-infrared motion detector designed to work with TB7200 and TB7300 thermostats. This advanced occupancy functionality provides advantageous energy savings during occupied hours without sacrificing occupant comfort.

APPLICATIONS

The range of applications covered with the PIR occupancy logic can be segmented into two important categories in terms of functionality. Both use different settings and have different behaviors:

- Hotel and lodging applications
- Standard commercial applications

Typical applications include:

- Stand-alone lodging FCU applications
- Networked lodging FCU applications fully integrated to a reservation system
- Networked or stand-alone conference rooms
- Networked or stand-alone classrooms units
- Any commercial offices that have random occupancy schedules during occupied hours as dictated by the function of the tenant
- Any controlled piece of HVAC equipment that may yield energy savings with the introduction of a new automatic stand-by level of occupancy.

MORE INFORMATION

The additional following documentation is available at Honeywell Buildings Forum (<http://buildingsforum.honeywell.com>).

- TB7200 Installation Instructions (form number 62-2019)
- TB7300 Installation Instructions (form number 62-2018)
- Occupancy Sensor Cover for TB7200/TB7300/TB7600 Series Thermostats (62-2021)
- BACnet Integration Manual for TB7200 & TB7300 (form number 63-4524) for detailed integration information.
- Wireless Reference Manual for TB7200, TB7300, and TB7600 Series (form number 63-4522).

Contents

Product Overview	1
Applications	1
More Information	1
Occupancy Sensor Cover Models	2
Occupancy Sensing Configuration Parameters	2
Important Things to Know	3
Typical Commercial Applications	7
Typical Lodging Applications	20
Installation	33
Specifications	35



OCCUPANCY SENSOR COVER MODELS

PIR Cover OS Number	Description	Compatible with the Following Thermostats
TB-PIR-FCU-C	PIR cover with Commercial FCU interface	TB73x0X5014(X)
TB-PIR-FCU-L	PIR cover with Hotel/Lodging interface	TB73x5X5014(X)
TB-PIR-ZN	PIR cover for zoning thermostats	All TB7200 Series

OCCUPANCY SENSING CONFIGURATION PARAMETERS

The following configuration parameters are specifically provided as standard on all TB7200 and TB7300 Series thermostats. They are associated with the advanced occupancy functionality introduced with the addition of a PIR cover or a remote PIR sensor. These parameters will allow the installer to set the thermostat occupancy functions exactly as required by the application.

Their functionality only becomes active if a PIR occupancy sensor cover is connected or one of the binary/digital input is configured to use a remote PIR sensing device.

Configuration Parameter	Description of Configuration parameter
BI or DI input door setting Default: None for no function used	<p>It is possible to configure some of the digital or binary inputs to effectively use the advanced functions allowed by the installation of a door switch contact. This function is mostly used with fan coil units in lodging applications</p> <p>When a door contact is used and configured, the Stand-By timer is no longer active. The occupancy toggle between occupied and stand-by is now dictated by both the door contact and the PIR cover.</p> <ul style="list-style-type: none"> • Movement detected by the PIR cover = Always occupied • Door opens / closes detected by the door switch = Stand-by mode
Stand-by Heating Setpoint: Default: 69 °F (20.5 °C)	<p>This parameter sets the stand-by heating setpoint value.</p> <p>The set value of this parameter should reside between the occupied and unoccupied heating setpoints and make sure that the difference between the stand-by and occupied value can be recovered in a timely fashion when movement is detected in the zone.</p> <p>Adjustable from 40 to 90 °F (4.5 to 32 °C) in 0.5 degree increments.</p>
Stand-by Cooling Setpoint: Default: 78 °F (25.5 °C)	<p>This parameter sets the stand-by cooling setpoint value.</p> <p>The set value of this parameter should reside between the occupied and unoccupied cooling setpoints and make sure that the difference between the stand-by and occupied value can be recovered in a timely fashion when movement is detected in the zone.</p> <p>Adjustable from 54 to 100 °F (12.2 to 37.8 °C) in 0.5 degree increments.</p>
Stand-by Time: Default 0.5 hours	<p>This parameter sets the time delay between the moment where the PIR cover detected the last movement in the area and the time which the thermostat stand-by mode and setpoints become active.</p> <p>Adjustable from 0.5 to 24 hours in .5hr increments</p>
Unoccupied Time: Default 0.0 hours	<p>If no movement is detected in the area and the current mode is stand-by, this parameter will then set the time delay between the moment where the thermostat toggles to stand-by mode and the time which the thermostat unoccupied mode and setpoints become active.</p> <p>The factory value or 0.0 hours: Setting this parameter to its default value of 0.0 hours disables the unoccupied timer. This prevents the thermostat from drifting from stand-by mode to unoccupied mode when PIR functions are used</p> <p>Adjustable from 0.0 to 24 hours in .5hr increments</p>

IMPORTANT THINGS TO KNOW

When reviewing the following document and planning an application using a Honeywell thermostat with PIR functionality, please remember the important following notes:

- Configuration of PIR Functions: All PIR application related configuration parameters are displayed in the configuration menu or available as objects in the network object list. However, the advanced occupancy functionality of a PIR attached to a thermostat is only enabled if either:
 - A Honeywell occupancy sensor cover is installed on the thermostat
 - A remote input is configured as a remote PIR sensor (Motion NO or Motion NC)
- PIR Cover Warm-Up Period: When occupancy sensor accessory cover is used and a thermostat is powered up; there will be a 1 minute warm up period before any local movements can being detected and acknowledged by the PIR sensing device. The local status LEDs for the occupancy sensor cover will also not be active during that one minute period.

Only when that 1 minute period has elapsed after initial power up of the thermostat will the PIR functionality and local movement status LEDs be activated.

- Setpoints: The implemented stand-by setpoints are under the same limitations and restrictions as the occupied and unoccupied ones. This means that:
 - They use exactly the same range:
 - Heating setpoints: 40 to 90 °F (4.5 to 32.0 °C)
 - Cooling setpoints: 54 to 100 °F (12.0 to 37.5 °C)
 - They are always limited by the applied minimum deadband configuration
They will be limited by the Heat Maximum and Cool Minimum configuration parameters

All individual cooling setpoints and all individual heating setpoints can be set independently. However, A typical arrangement will always have the set value of the stand-by parameters residing between the corresponding occupied and unoccupied set-point values.

The installer must make sure that the difference between the stand-by and occupied value can be recovered in a timely fashion when movement is detected in the zone and large enough to warrant maximum energy savings.

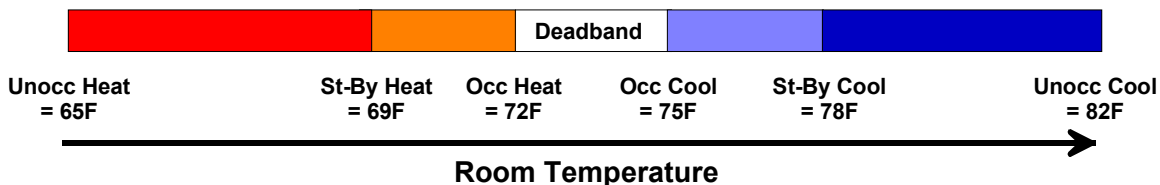

- **Application Range:** The range of applications covered with the PIR occupancy logic can be segmented in 2 categories in terms of functionality. Both use different settings and have different behaviors:
 - Hotel and lodging applications
 - Standard commercial applications

Hotel and Lodging Applications can benefit the addition of an entry door switch wired to one of the appropriately configured remote input of a thermostat.

When a door contact is used and configured, the Stand-By timer and its configuration are no longer active or used. The occupancy front toggle between occupied and stand-by is now simply dictated by both the door contact and the PIR sensing device used.

If movements are detected by the PIR cover, the room will always be occupied. The switch back to stand-by mode will only happen if the door switch toggles open / close. Please review attached lodging application examples in the document for more information

Standard Commercial Applications would not typically use a remote door switch contact attached to the thermostat.

PIR occupancy functionality is simply dictated by both the Stand-By Timer and Unoccupied Timer configuration value and movements being present or not in the area. Please review attached typical commercial application examples in the document for more information

- **Unoccupied Timer Disable:** In certain application cases, it may be desired to never let the local area enter the unoccupied mode and always stay at the stand-by occupancy level when no activity is present.

This allows for advanced flexibility when used in conjunction with a network or in cases when areas always need to be on stand-by status ready to respond to demand at any point in time.

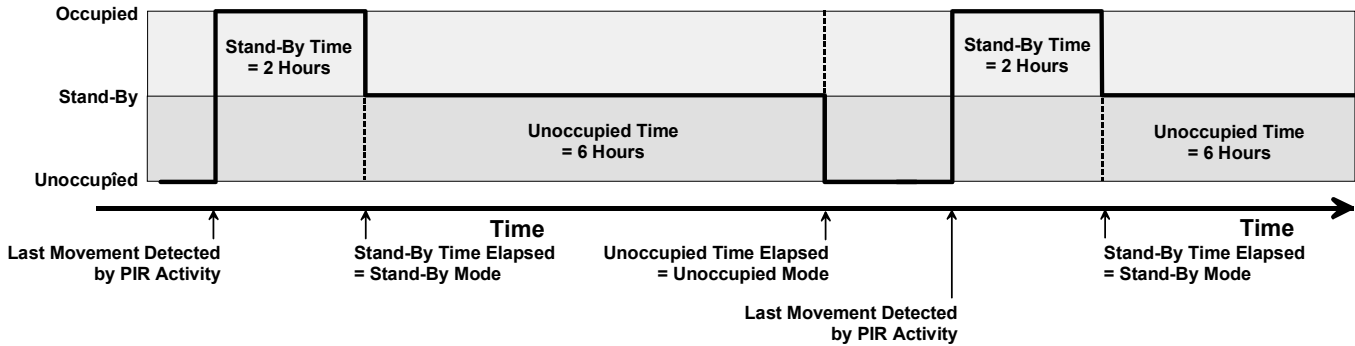

Fig. 1. Unoccupied timer set 6 Hours and stand-by timer set to 2 hours

When the local PIR occupancy routine is running at the thermostat, the zone will drift into unoccupied mode when the unoccupied timer is set above its factory default value of 0.0 hours

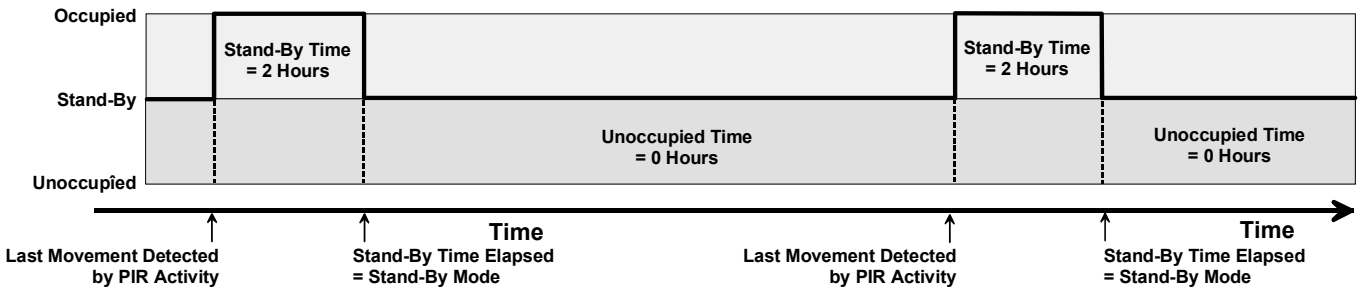

Fig. 2. Unoccupied timer set 0 Hours and stand-by timer set to 2 hours

When the local PIR occupancy routine is running at the thermostat, the zone will never drift into unoccupied mode when the unoccupied timer is set to its factory default value of 0.0 hours

- **Network Priority and Local Occupancy Routine:** The internal PIR occupancy logic implementation in conjunction with network commands has been conceived to give the most flexibility while allowing for simple implementation and use.

Network Occupancy Commands: All TB7200 and TB7300 series thermostat have 3 occupancy command levels. This is valid for all BACnet-MS-TP and wireless thermostats.

Table 1. Three levels occupancy state level commands.

State Occupancy Command Levels	Function
Local occupancy	<ul style="list-style-type: none"> Releases the thermostat to its own occupancy schemes This may be a PIR sensing device, a local schedule or an occupancy routine done by one of the digital input This state command level is used to effectively release the thermostat to use the PIR functions
Occupied	<ul style="list-style-type: none"> Leaves the thermostat in occupied mode and cancels any local occupancy functions, including the PIR occupancy routine This state command level is used to force the zone to be always occupied
Unoccupied	<ul style="list-style-type: none"> Leaves the thermostat in unoccupied mode and cancels any local occupancy functions, including the PIR occupancy routine This state command level is used to force the zone to be always unoccupied. The only local possible command is a local override if the thermostat is equipped with such an option or if the local keypad lockout allows so

Stand-by is *never* a commandable level. It only exists as a feedback status level.

Network Occupancy Feedback Status: All TB7200 and TB7300 series thermostats have 4 occupancy feedback levels. This is valid for BACnet-MS-TP or wireless models.

State Occupancy Command Levels	Function
Override / By-Pass	Indicates that the zone is currently local occupied override mode from the unoccupied state This function will operate like a normal local override and its time value is as dictated by the ToccTime configuration parameter setting
Occupied	Indicates that the zone is currently occupied This effective feedback state may be driven by a local occupancy routine like a PIR sensor or by an occupied network command
Stand-By	Indicates that the zone is currently in stand-by mode This effective feedback state <i>can only</i> be driven by a local PIR occupancy routine
Unoccupied	Indicates that the zone is currently unoccupied This effective feedback state may be driven by a local occupancy routine like a PIR sensor or by an unoccupied network command

1. MV Objects Used for Occupancy Commands and Feedback

Object Name	BACnet Object ID*	BACnet/Wireless Index	Text
Occupancy Command	MV 13	1	Local Occupancy (PIR or Internal Schedule)
		2	Occupied
		3	Unoccupied
Effective Occupancy	MV 83	1	Occupied
		2	Unoccupied
		3	Temporary Occupied
		4	Stand-By

* MV Object IDs only apply to BACnet thermostats.

Initial State, PIR Occupancy Routine: The initial effective occupancy state on power-up with either a PIR cover is present or one of the inputs is configured for a remote PIR sensor is always:

- In stand-alone applications at power-up: Local occupancy mode = Stand-by
- From a previous network unoccupied command: Local occupancy mode = Stand-by
- From a previous network occupied command: Local occupancy mode = Occupied.

When the network effectively releases a thermostat to its local PIR routine from a previous occupied or unoccupied network state, the resulting occupancy state is always Stand-By mode.

Initial Power-Up, Stand-Alone or Networked

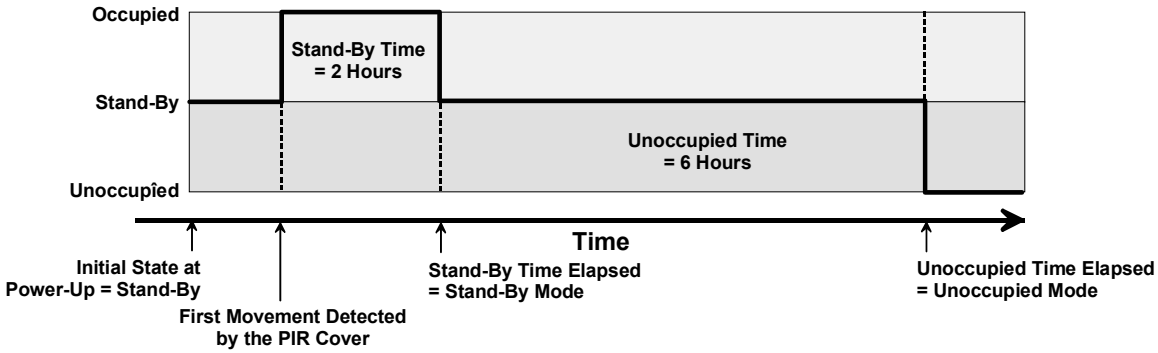

After Receiving the Local Occupancy / PIR Network Command From a Previous Unoccupied State

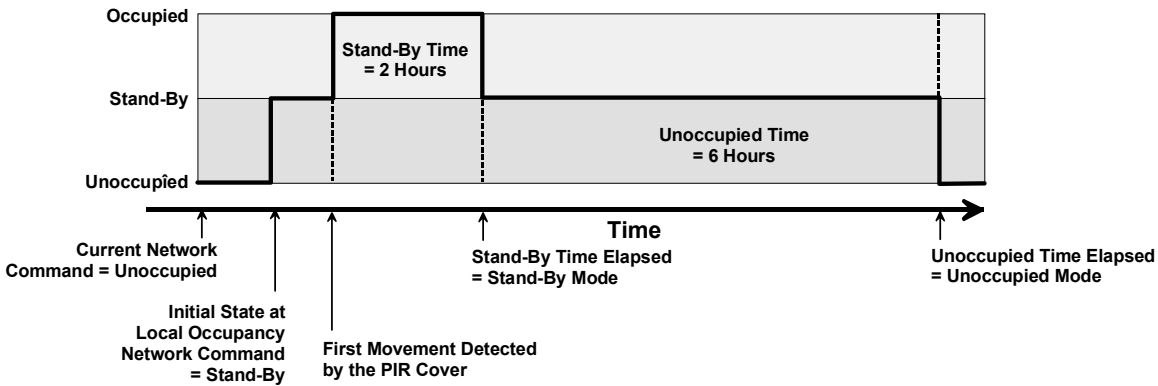

After Receiving the Local Occupancy / PIR Network Command From a Previous Occupied State

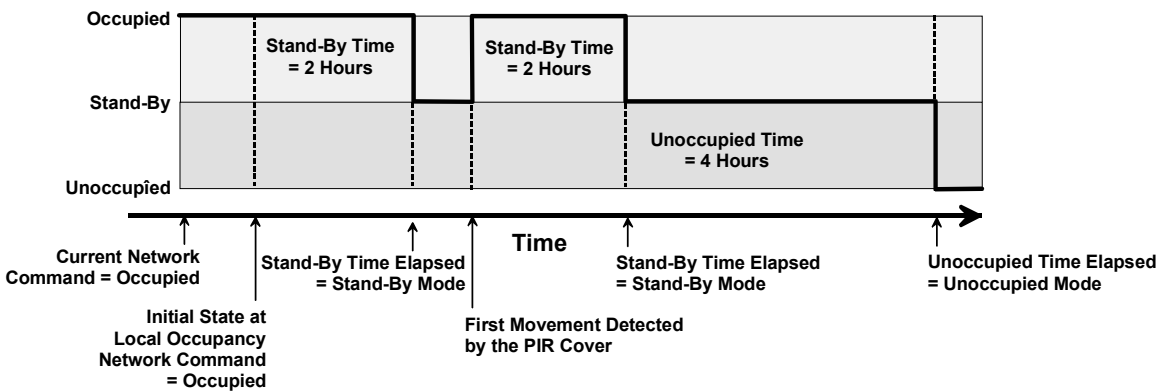

TYPICAL COMMERCIAL APPLICATIONS

This section provides some typical networked and stand-alone commercial applications using the TB7300 Series. Each application includes configuration information and describes system behavior using the occupancy sensing options.

Application Number	PIR Levels of Occupancy	PIR Cover Used	Remote PIR Used	Network interface
1	3	Yes	No	Yes, BACnet or wireless
2	2	Yes	No	Yes, BACnet or wireless
3	3	No	Yes	Yes, BACnet or wireless
4	2	No	Yes	Yes, BACnet or wireless
5	3	Yes	Yes	Yes, BACnet or wireless
6	2	Yes	Yes	Yes, BACnet or wireless
7	3	Yes	No	None, stand-alone
8	2	Yes	No	None, stand-alone
9	3	No	Yes	None, stand-alone
10	2	No	Yes	None, stand-alone
11	3	Yes	Yes	None, stand-alone
12	2	Yes	Yes	None, stand-alone

1. TB7300 networked fan coil application—3 levels of occupancy with an occupancy sensor cover

Set-up and Configuration	
Thermostat used	TB73x0X5014 (commercial models)
PIR used	TB-PIR-FCU-C cover
BI2 Configuration	None, no function
Stand-by timer value	2.0 hours
Unoccupied timer value	6.0 hours
Network interface used	BACnet MS/TP or wireless

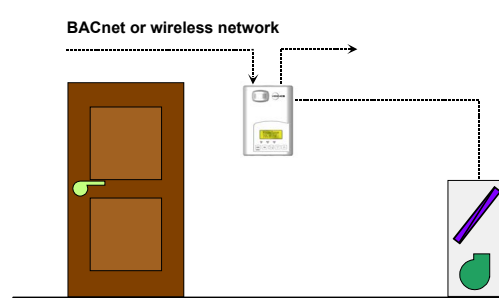

Sequence of operation:

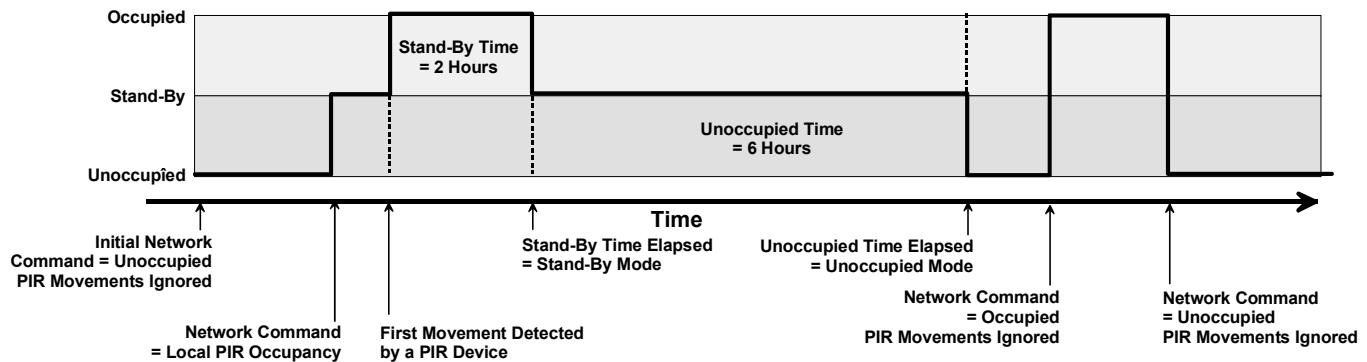

At initial power-up, when the thermostat 24 Vac power supply is applied; if there is no occupancy network command received by the thermostat and if the PIR device does not detect any movement, the initial occupancy of the zone will be stand-by mode.

Occupied state network command

At any time, an occupied network command will always force the local zone to be in occupied mode and to use the occupied setpoints.

Unoccupied state network command

At any time, an unoccupied network command will always force the local zone to be in unoccupied mode and to use the unoccupied setpoints. If the thermostat local override function is not locked out by configuration, the local user may initiate a temporary local override to occupied as dictated by the temporary occupancy time configuration parameter setting.

Local occupancy state network command

If previously in unoccupied mode when the thermostat receives a local occupancy state network command, the local PIR occupancy loop will now be enabled. If the PIR device does not then detect any movement, the occupancy of the zone will be stand-by mode.

As soon as the PIR device detects a movement or motion while in the local occupancy state network command, the occupancy status switches to occupied and the occupied setpoints are used.

Anytime the PIR device detects local motion, the elapsed stand-by timer value will be reset. If no motion is detected in the zone for the entire stand-by timer duration, then the room switches to stand-by mode and the stand-by setpoints are used.

While in stand-by mode, if no motion is detected in the zone for the entire unoccupied timer duration, then the room switches to unoccupied mode and the unoccupied setpoints are used.

At anytime, if the PIR device detects a local movement or motion, the occupancy status switches to occupied and the occupied setpoints are used.

2. TB7300 networked fan coil application—2 levels of occupancy with occupancy sensor cover

Set-up and Configuration	
Thermostat used	TB73x0X5014 (commercial models)
PIR used	TB-PIR-FCU-C cover
BI2 Configuration	None, no function
Stand-by timer value	2.0 hours
Unoccupied timer value	0.0 hours
Network interface used	BACnet MS/TP or wireless

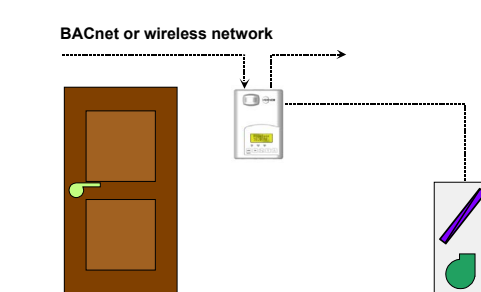

Sequence of operation:

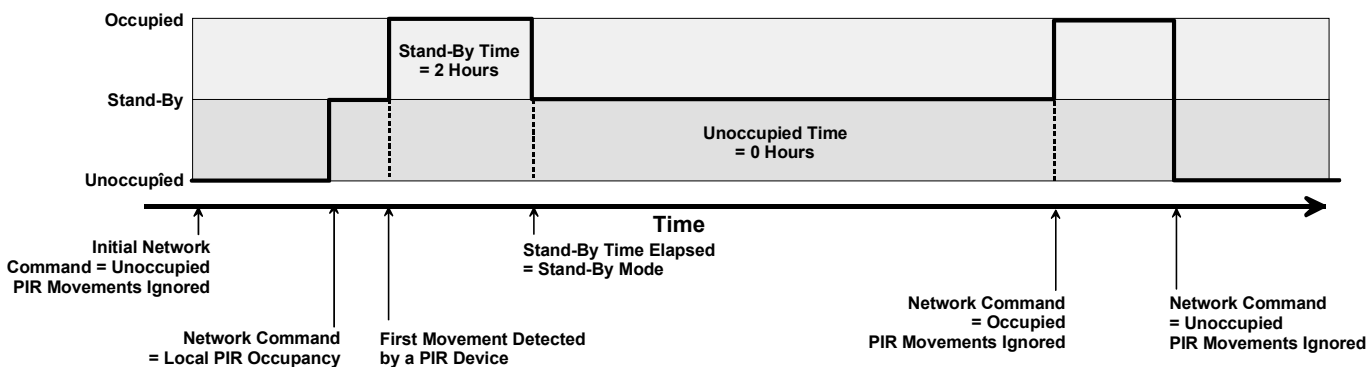

At initial power-up, when the thermostat 24 Vac power supply is applied; if there is no occupancy network command received by the thermostat and if the PIR device does not detect any movement, the initial occupancy of the zone will be stand-by mode.

Occupied state network command

At any time, an occupied network command will always force the local zone to be in occupied mode and to use the occupied setpoints.

Unoccupied state network command

At any time, an unoccupied network command will always force the local zone to be in unoccupied mode and to use the unoccupied setpoints. If the thermostat local override function is not locked out by configuration, the local user may initiate a temporary local override to occupied as dictated by the temporary occupancy time configuration parameter setting.

Local occupancy state network command

If previously in unoccupied mode when then the thermostat receives a local occupancy state network command, the local PIR occupancy loop will now be enabled. If the PIR device does not then detect any movement, the occupancy of the zone will be stand-by mode.

As soon as the PIR device detects a movement or motion while in the local occupancy state network command, the occupancy status switches to occupied and the occupied setpoints are used.

Anytime the PIR device detects local motion, the elapsed stand-by timer value will be reset. If no motion is detected in the zone for the entire stand-by timer duration, then the room switches to stand-by mode and the stand-by setpoints are used.

At anytime, if the PIR device detects a local movement or motion, the occupancy status switches to occupied and the occupied setpoints are used.

While in the local occupancy state network command, the local zone never goes into unoccupied mode and the unoccupied setpoints are never used

3. TB7300 networked fan coil application—3 levels of occupancy with a remote PIR sensor

Set-up and Configuration	
Thermostat used	TB73x0X5014X (commercial models)
PIR used	BI1 configured for remote PIR sensor
BI2 Configuration	None, no function
Stand-by timer value	2.0 hours
Unoccupied timer value	6.0 hours
Network interface used	BACnet MS/TP or wireless

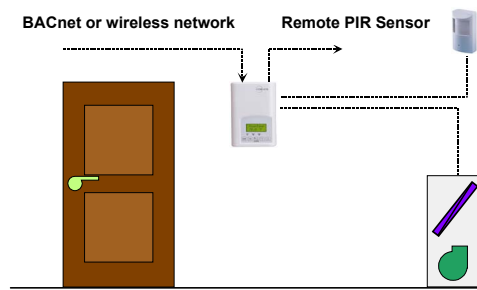

Sequence of operation:

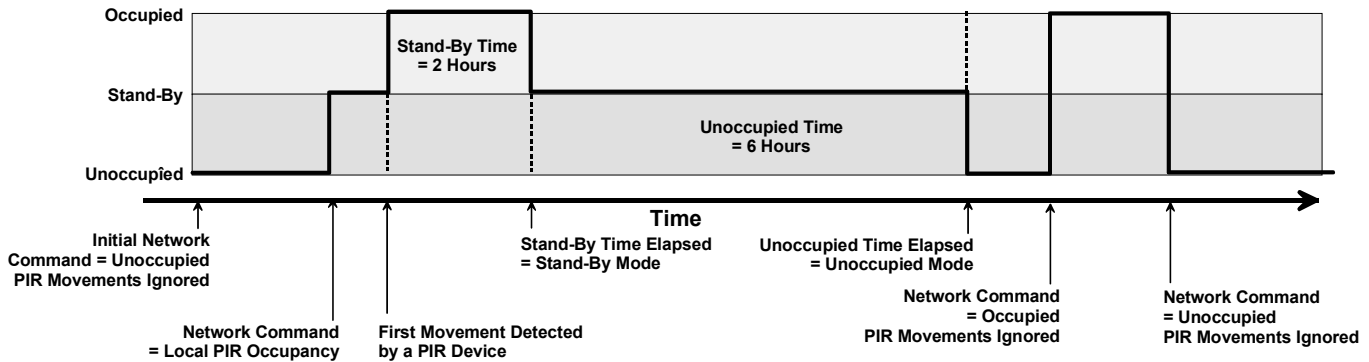

At initial power-up, when the thermostat 24 Vac power supply is applied; if there is no occupancy network command received by the thermostat and if the PIR device does not detect any movement, the initial occupancy of the zone will be stand-by mode.

Occupied state network command

At any time, an occupied network command will always force the local zone to be in occupied mode and to use the occupied setpoints.

Unoccupied state network command

At any time, an unoccupied network command will always force the local zone to be in unoccupied mode and to use the unoccupied setpoints. If the thermostat local override function is not locked out by configuration, the local user may initiate a temporary local override to occupied as dictated by the temporary occupancy time configuration parameter setting.

Local occupancy state network command

If previously in unoccupied mode when the thermostat receives a local occupancy state network command, the local PIR occupancy loop will now be enabled. If the PIR device does not then detect any movement, the occupancy of the zone will be stand-by mode.

As soon as the PIR device detects a movement or motion while in the local occupancy state network command, the occupancy status switches to occupied and the occupied setpoints are used.

Anytime the PIR device detects local motion, the elapsed stand-by timer value will be reset. If no motion is detected in the zone for the entire stand-by timer duration, then the room switches to stand-by mode and the stand-by setpoints are used.

While in stand-by mode, if no motion is detected in the zone for the entire unoccupied timer duration, then the room switches to unoccupied mode and the unoccupied setpoints are used.

At anytime, if the PIR device detects a local movement or motion, the occupancy status switches to occupied and the occupied setpoints are used.

4. TB7300 networked fan coil application —2 levels of occupancy with a remote PIR sensor

Set-up and Configuration	
Thermostat used	TB73x0X5014X (commercial models)
PIR used	BI1 configured for remote PIR sensor
BI2 Configuration	None, no function
Stand-by timer value	2.0 hours
Unoccupied timer value	0.0 hours
Network interface used	BACnet MS/TP or wireless

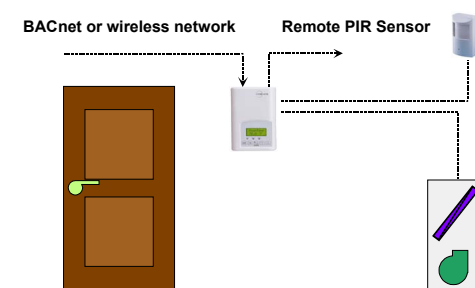

Sequence of operation:

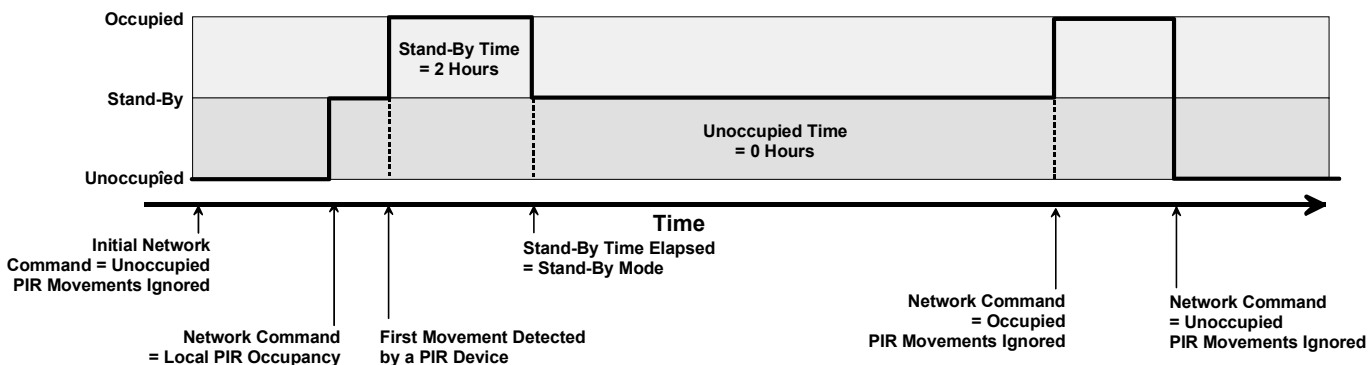

At initial power-up, when the thermostat 24 Vac power supply is applied; if there is no occupancy network command received by the thermostat and if the PIR device does not detect any movement, the initial occupancy of the zone will be stand-by mode.

Occupied state network command

At any time, an occupied network command will always force the local zone to be in occupied mode and to use the occupied setpoints.

Unoccupied state network command

At any time, an unoccupied network command will always force the local zone to be in unoccupied mode and to use the unoccupied setpoints. If the thermostat local override function is not locked out by configuration, the local user may initiate a temporary local override to occupied as dictated by the temporary occupancy time configuration parameter setting.

Local occupancy state network command

If previously in unoccupied mode when the thermostat receives a local occupancy state network command, the local PIR occupancy loop will now be enabled. If the PIR device does not then detect any movement, the occupancy of the zone will be stand-by mode.

As soon as the PIR device detects a movement or motion while in the local occupancy state network command, the occupancy status switches to occupied and the occupied setpoints are used.

Anytime the PIR device detects local motion, the elapsed stand-by timer value will be reset. If no motion is detected in the zone for the entire stand-by timer duration, then the room switches to stand-by mode and the stand-by setpoints are used.

At anytime, if the PIR device detects a local movement or motion, the occupancy status switches to occupied and the occupied setpoints are used.

While in the local occupancy state network command, the local zone never goes into unoccupied mode and the unoccupied setpoints are never used.

5. TB7300 networked fan coil application—3 levels of occupancy with dual PIR sensors

Set-up and Configuration	
Thermostat used	TB73x0X5014X (commercial models)
PIR used	BI1 configured for remote PIR sensor and TB-PIR-FCU-C cover
BI2 Configuration	None, no function
Stand-by timer value	2.0 hours
Unoccupied timer value	6.0 hours
Network interface used	BACnet MS/TP or wireless

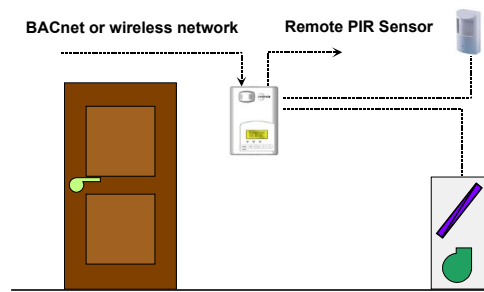

Sequence of operation:

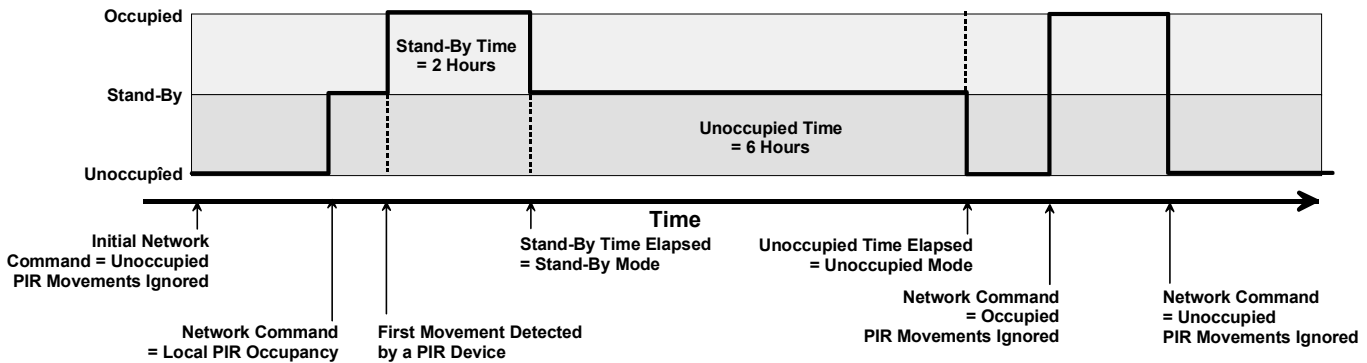

At initial power-up, when the thermostat 24 Vac power supply is applied; if there is no occupancy network command received by the thermostat and if the PIR devices do not detect any movement, the initial occupancy of the zone will be stand-by mode.

Occupied state network command

At any time, an occupied network command will always force the local zone to be in occupied mode and to use the occupied setpoints.

Unoccupied state network command

At any time, an unoccupied network command will always force the local zone to be in unoccupied mode and to use the unoccupied setpoints. If the thermostat local override function is not locked out by configuration, the local user may initiate a temporary local override to occupied as dictated by the temporary occupancy time configuration parameter setting.

Local occupancy state network command

If previously in unoccupied mode when the thermostat receives a local occupancy state network command, the local PIR occupancy loop will now be enabled. If the PIR devices do not then detect any movement, the occupancy of the zone will be stand-by mode.

As soon as a PIR device detects a movement or motion while in the local occupancy state network command, the occupancy status switches to occupied and the occupied setpoints are used.

Anytime the PIR device detects local motion, the elapsed stand-by timer value will be reset. If no motion is detected in the zone for the entire stand-by timer duration, then the room switches to stand-by mode and the stand-by setpoints are used.

While in stand-by mode, if no motion is detected in the zone for the entire unoccupied timer duration, then the room switches to unoccupied mode and the unoccupied setpoints are used.

At anytime, if a PIR device detects a local movement or motion, the occupancy status switches to occupied and the occupied setpoints are used.

6. TB7300 networked fan coil application—2 levels of occupancy with dual PIR sensors

Set-up and Configuration	
Thermostat used	TB73x0X5014X (commercial models)
PIR used	BI1 configured for remote PIR sensor and TB-PIR-FCU-C cover
BI2 Configuration	None, no function
Stand-by timer value	2.0 hours
Unoccupied timer value	0.0 hours
Network interface used	BACnet MS/TP or wireless

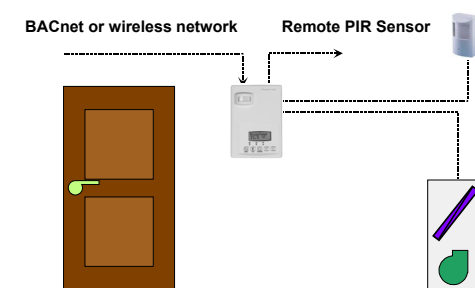

Sequence of operation:

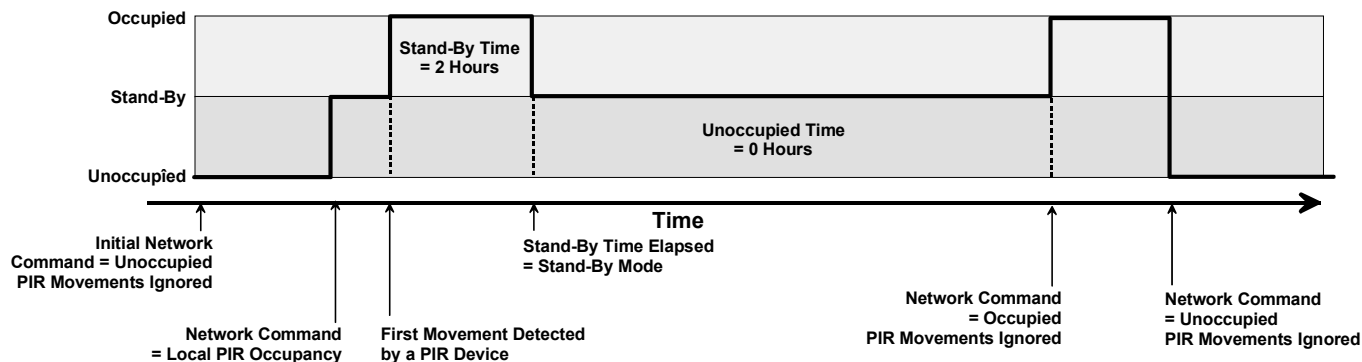

At initial power-up, when the thermostat 24 Vac power supply is applied; if there is no occupancy network command received by the thermostat and if the PIR devices do not detect any movement, the initial occupancy of the zone will be stand-by mode.

Occupied state network command

At any time, an occupied network command will always force the local zone to be in occupied mode and to use the occupied setpoints.

Unoccupied state network command

At any time, an unoccupied network command will always force the local zone to be in unoccupied mode and to use the unoccupied setpoints. If the thermostat local override function is not locked out by configuration, the local user may initiate a temporary local override to occupied as dictated by the temporary occupancy time configuration parameter setting.

Local occupancy state network command

If previously in unoccupied mode when the thermostat receives a local occupancy state network command, the local PIR occupancy loop will now be enabled. If the PIR devices do not then detect any movement, the occupancy of the zone will be stand-by mode.

As soon as the PIR device detects a movement or motion while in the local occupancy state network command, the occupancy status switches to occupied and the occupied setpoints are used.

Anytime a PIR device detects local motion, the elapsed stand-by timer value will be reset. If no motion is detected in the zone for the entire stand-by timer duration, then the room switches to stand-by mode and the stand-by setpoints are used.

At anytime, if a PIR device detects a local movement or motion, the occupancy status switches to occupied and the occupied setpoints are used.

While in the local occupancy state network command, the local zone never goes into unoccupied mode and the unoccupied setpoints are never used.

7. TB7300 stand-alone fan coil application—3 levels of occupancy with an occupancy sensor cover

Set-up and Configuration	
Thermostat used	TB73x0X5014X (commercial models)
PIR used	TB-PIR-FCU-C cover
BI2 Configuration	None, no function
Stand-by timer value	2.0 hours
Unoccupied timer value	6.0 hours
Network interface used	None, stand-alone

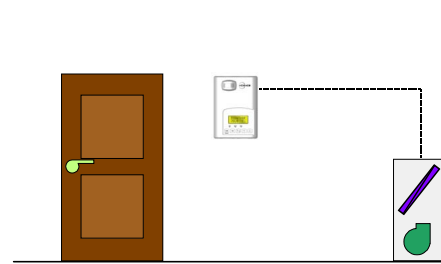

Sequence of operation:

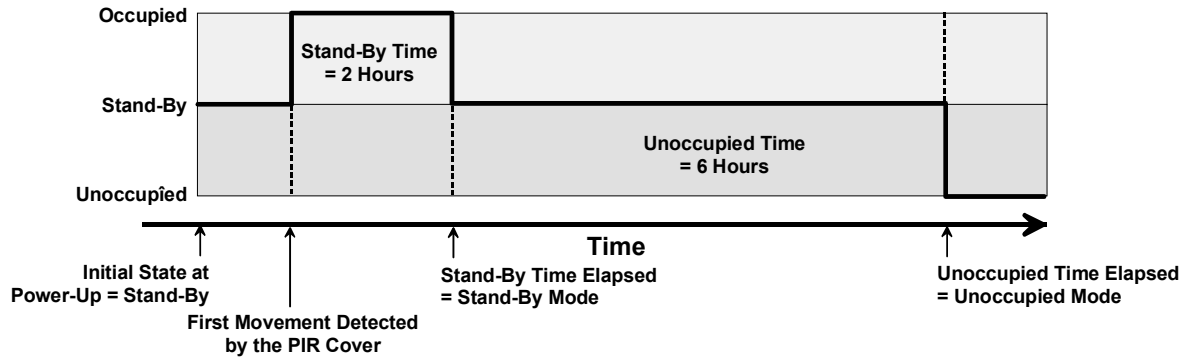

At initial power-up, when the thermostat 24 Vac power supply is applied; the initial occupancy of the zone will be stand-by mode if the PIR device does not detect any movement.

As soon as the PIR device detects a movement or motion, the occupancy status switches to occupied and the occupied setpoints are used.

Anytime the PIR device detects local motion, the elapsed stand-by timer value will be reset. If no motion is detected in the zone for the entire stand-by timer duration, then the room switches to stand-by mode and the stand-by setpoints are used.

While in stand-by mode, if no motion is detected in the zone for the entire unoccupied timer duration, then the room switches to unoccupied mode and the unoccupied setpoints are used.

At anytime, if the PIR device detects a local movement or motion, the occupancy status switches to occupied and the occupied setpoints are used.

8. TB7300 stand-alone fan coil application—2 levels of occupancy with an occupancy sensor cover

Set-up and Configuration	
Thermostat used	TB73x0X5014X (commercial models)
PIR used	TB-PIR-FCU-C cover
BI2 Configuration	None, no function
Stand-by timer value	2.0 hours
Unoccupied timer value	0.0 hours
Network interface used	None, stand-alone

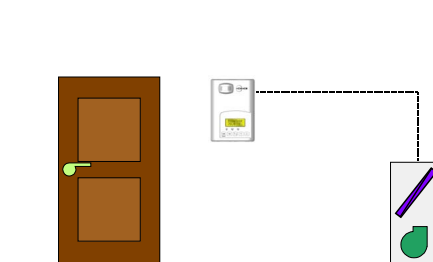

Sequence of operation:

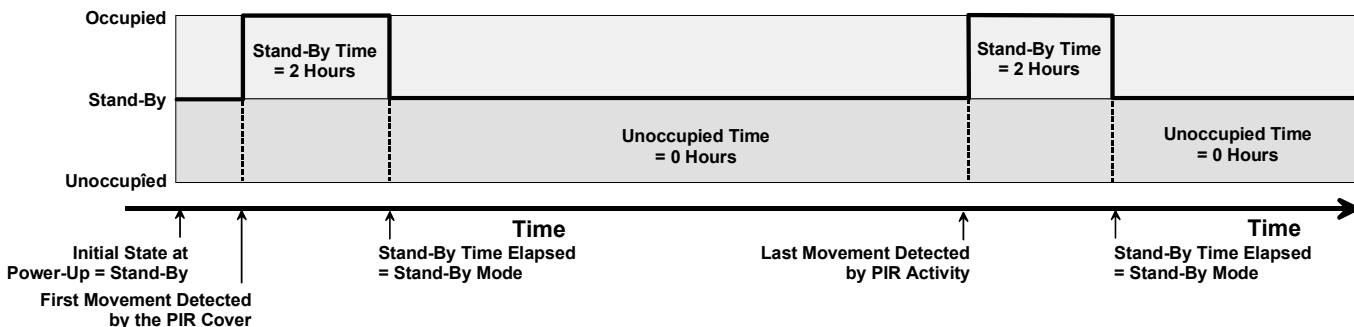

At initial power-up, when the thermostat 24 Vac power supply is applied; the initial occupancy of the zone will be stand-by mode if the PIR device does not detect any movement.

As soon as the PIR device detects a movement or motion, the occupancy status switches to occupied and the occupied setpoints are used.

Anytime the PIR device detects local motion, the elapsed stand-by timer value will be reset. If no motion is detected in the zone for the entire stand-by timer duration, then the room switches to stand-by mode and the stand-by setpoints are used.

At anytime, if the PIR device detects a local movement or motion, the occupancy status switches to occupied and the occupied setpoints are used.

The local zone never goes into unoccupied mode and the unoccupied setpoints are never used.

9. TB7300 stand-alone fan coil application—3 levels of occupancy with a remote PIR sensor

Set-up and Configuration	
Thermostat used	TB73x0X5014X (commercial models)
PIR used	BI1 configured for remote PIR sensor
BI2 Configuration	None, no function
Stand-by timer value	2.0 hours
Unoccupied timer value	6.0 hours
Network interface used	None, stand-alone

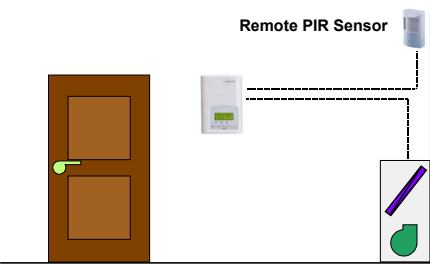

Sequence of operation

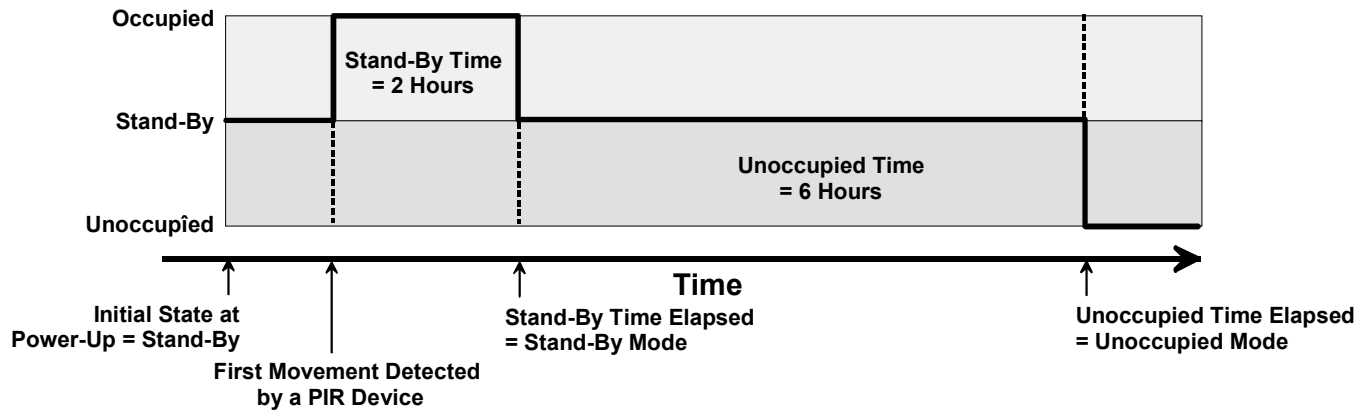

At initial power-up, when the thermostat 24 Vac power supply is applied; the initial occupancy of the zone will be stand-by mode if the PIR device does not detect any movement.

As soon as the PIR device detects a movement or motion, the occupancy status switches to occupied and the occupied setpoints are used.

Anytime the PIR device detects local motion, the elapsed stand-by timer value will be reset. If no motion is detected in the zone for the entire stand-by timer duration, then the room switches to stand-by mode and the stand-by setpoints are used.

While in stand-by mode, if no motion is detected in the zone for the entire unoccupied timer duration, then the room switches to unoccupied mode and the unoccupied setpoints are used.

At anytime, if the PIR device detects a local movement or motion, the occupancy status switches to occupied and the occupied setpoints are used.

10. TB7300 stand-alone fan coil application—2 levels of occupancy with a remote PIR sensor

Set-up and Configuration	
Thermostat used	TB73x0X5014X (commercial models)
PIR used	BI1 configured for remote PIR sensor
BI2 Configuration	None, no function
Stand-by timer value	2.0 hours
Unoccupied timer value	0.0 hours
Network interface used	None, stand-alone

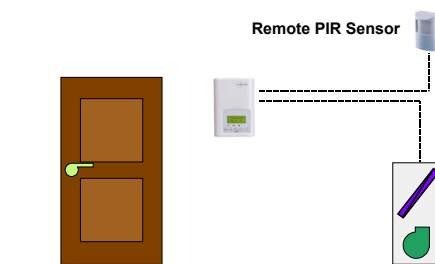

Sequence of operation

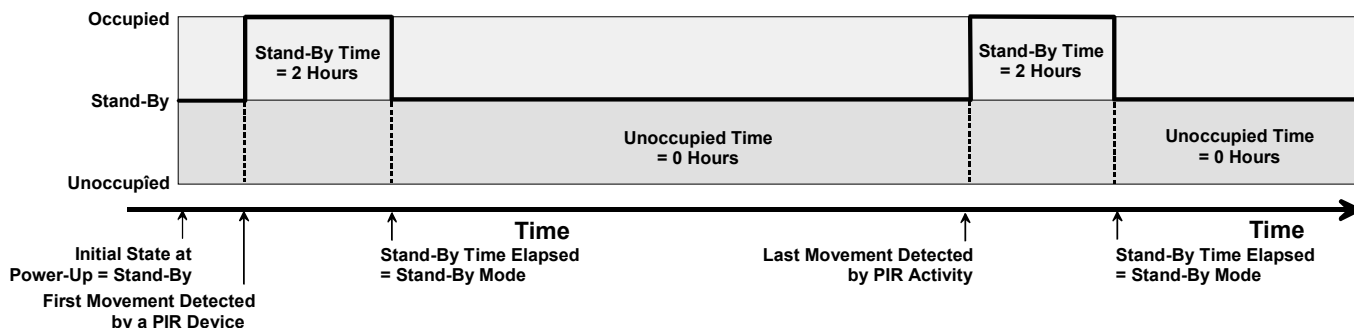

At initial power-up, when the thermostat 24 Vac power supply is applied; the initial occupancy of the zone will be stand-by mode if the PIR device does not detect any movement.

As soon as the PIR device detects a movement or motion, the occupancy status switches to occupied and the occupied setpoints are used.

Anytime the PIR device detects local motion, the elapsed stand-by timer value will be reset. If no motion is detected in the zone for the entire stand-by timer duration, then the room switches to stand-by mode and the stand-by setpoints are used.

At anytime, if the PIR device detects a local movement or motion, the occupancy status switches to occupied and the occupied setpoints are used.

The local zone never goes into unoccupied mode and the unoccupied setpoints are never used.

11. TB7300 stand-alone fan coil application—3 levels of occupancy with dual PIR sensors

Set-up and Configuration	
Thermostat used	TB73x0X5014 (commercial models)
PIR used	BI1 configured for remote PIR sensor and TB-PIR-FCU-C cover
BI2 Configuration	None, no function
Stand-by timer value	2.0 hours
Unoccupied timer value	6.0 hours
Network interface used	None, stand-alone

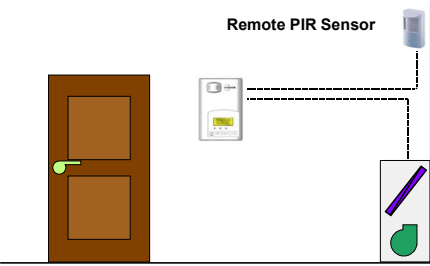

Sequence of operation:

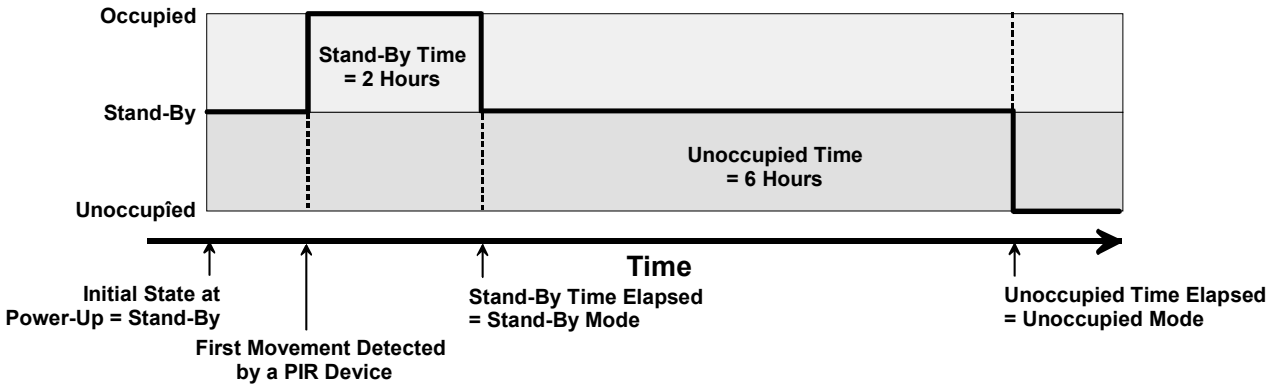

At initial power-up, when the thermostat 24 Vac power supply is applied; the initial occupancy of the zone will be stand-by mode if the PIR devices do not detect any movement.

As soon as any of the PIR devices detect a movement or motion, the occupancy status switches to occupied and the occupied setpoints are used.

Anytime local motion is detected by one of the PIR devices, the elapsed stand-by timer value will be reset. If either PIR devices in the zone detect no motion for the entire stand-by timer duration, then the room switches to stand-by mode and the stand-by setpoints are used.

While in stand-by mode, if no motion is detected in the zone by either PIR device for the entire unoccupied timer duration, then the room switches to unoccupied mode and the unoccupied setpoints are used.

At anytime, if one of the PIR devices detects a local movement or motion, the occupancy status switches to occupied and the occupied setpoints are used.

12. TB7300 stand-alone fan coil application—2 levels of occupancy with dual PIR sensors

Set-up and Configuration	
Thermostat used	TB73x0X5014X (commercial models)
PIR used	BI1 configured for remote PIR sensor and TB-PIR-FCU-C cover
BI2 Configuration	None, no function
Stand-by timer value	2.0 hours
Unoccupied timer value	0.0 hours
Network interface used	None, stand-alone

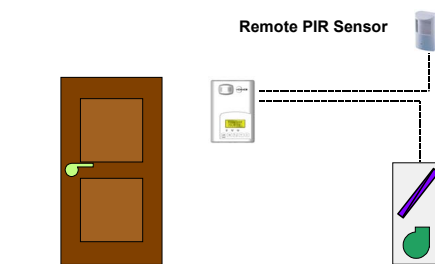

Sequence of operation:

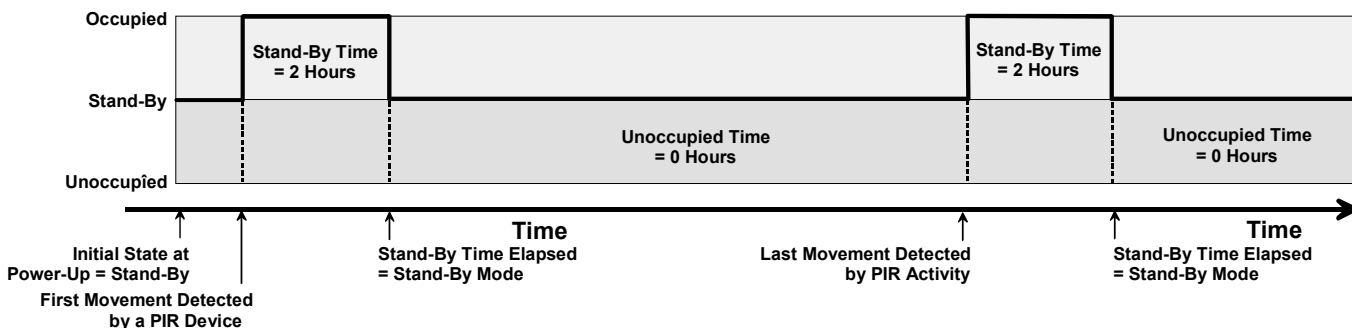

At initial power-up, when the thermostat 24 Vac power supply is applied; the initial occupancy of the zone will be stand-by mode if the PIR devices do not detect any movement.

As soon as either of the PIR devices detect a movement or motion, the occupancy status switches to occupied and the occupied setpoints are used.

Anytime local motion is detected by one of the PIR devices, the elapsed stand-by timer value will be reset. If either PIR devices in the zone detect no motion for the entire stand-by timer duration, then the room switches to stand-by mode and the stand-by setpoints are used.

At anytime, if one of the PIR devices detects a local movement or motion, the occupancy status switches to occupied and the occupied setpoints are used.

The local zone never goes into unoccupied mode and the unoccupied setpoints are never used.

TYPICAL LODGING APPLICATIONS

This section provides some typical networked and stand-alone hotel/lodging applications using the TB7300 Series. Each application includes configuration information and describes system behavior using the occupancy sensing options.

Application Number	PIR Levels of Occupancy	PIR Cover Used	Remote PIR Used	Network interface
1	3	Yes	No	Yes, BACnet or wireless
2	2	Yes	No	Yes, BACnet or wireless
3	3	No	Yes	Yes, BACnet or wireless
4	2	No	Yes	Yes, BACnet or wireless
5	3	Yes	Yes	Yes, BACnet or wireless
6	2	Yes	Yes	Yes, BACnet or wireless
7	3	Yes	No	None, stand-alone
8	2	Yes	No	None, stand-alone
9	3	No	Yes	None, stand-alone
10	2	No	Yes	None, stand-alone
11	3	Yes	Yes	None, stand-alone
12	2	Yes	Yes	None, stand-alone

Advanced network interface can be obtained when thermostats are fully integrated to the reservation system

In these cases, the occupancy network commands state enumerations text presented by a front end system can be expanded to better represent the nature of the application.

Occupancy network commands state	Front end system state text examples
Local Occupancy (PIR active)	Room rented PIR economy enabled
Occupied	Room rented high comfort assured
Unoccupied	Room not rented

1. TB7300 networked fan coil application—3 levels of occupancy with an occupancy sensor cover

Set-up and Configuration	
Thermostat used	TB73x5X5014X (lodging models)
PIR used	TB-PIR-FCU-L cover
BI2 Configuration	Door dry contact
Stand-by timer value	Not used
Unoccupied timer value	6.0 hours
Network interface used	BACnet MS/TP or wireless

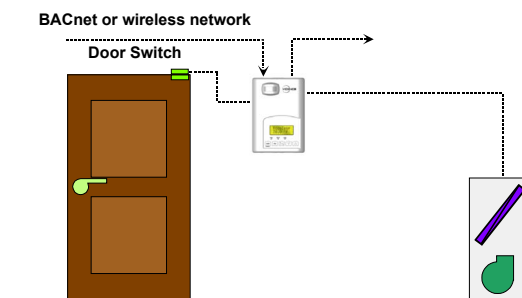

Advanced network interface can be obtained when thermostats are fully integrated to the reservation system. In these cases, the occupancy network commands state enumerations text presented by a front end system can be expanded to better represent the nature of the application.

Occupancy network commands state	Front end system state text examples
Local Occupancy (PIR active)	Room rented PIR economy enabled
Occupied	Room rented high comfort assured
Unoccupied	Room not rented

Sequence of operation:

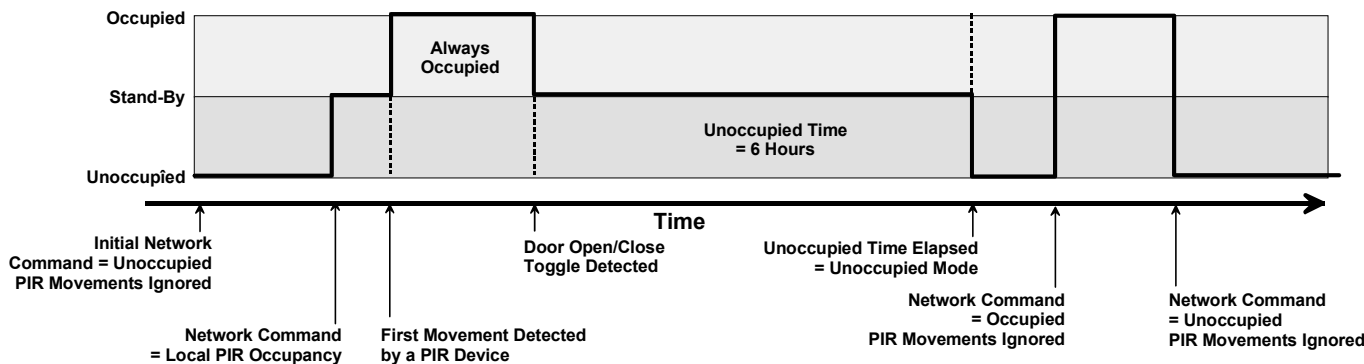

At initial power-up, when the thermostat 24 Vac power supply is applied; if there is no occupancy network command received by the thermostat and if the PIR device does not detect any movement, the initial occupancy of the zone will be stand-by mode.

Occupied state network command

At any time, an occupied network command will always force the local zone to be in occupied mode and to use the occupied setpoints.

Unoccupied state network command

At any time, an unoccupied network command will always force the local zone to be in unoccupied mode and to use the unoccupied setpoints. If the thermostat local override function is not locked out by configuration, the local user may initiate a temporary local override to occupied as dictated by the temporary occupancy time configuration parameter setting.

Local occupancy state network command

If previously in unoccupied mode when the thermostat receives a local occupancy state network command, the local PIR occupancy loop will now be enabled. If the PIR device does not then detect any movements, the occupancy of the zone will be stand-by mode.

As soon as the PIR device detects a movement or motion, the occupancy status switches to occupied and the occupied setpoints are used. The room will then be in occupied mode until a door toggle is detected.

If a door toggle is detected, then the room switches to stand-by mode and the stand-by setpoints are used. If any occupants are left in the room, local movements must be seen to resume the occupied mode.

While in stand-by mode, if no motion is detected in the zone for the entire unoccupied timer duration, then the room switches to unoccupied mode and the unoccupied setpoints are used. At anytime, if the PIR device detects a local movement or motion, the occupancy status switches to occupied and the occupied setpoints are used.

2. TB7300 networked fan coil application—2 levels of occupancy with an occupancy sensor cover

Set-up and Configuration	
Thermostat used	TB73x5X5014X (lodging models)
PIR used	TB-PIR-FCU-L cover
BI2 Configuration	Door dry contact
Stand-by timer value	Not used
Unoccupied timer value	0.0 hours
Network interface used	BACnet MS/TP or wireless

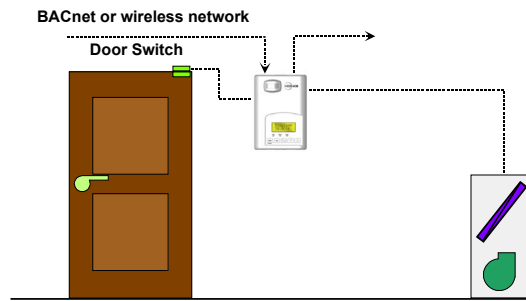

Advanced network interface can be obtained when thermostats are fully integrated to the reservation system.

In these cases, the occupancy network commands state enumeration text presented by a front end system can be expanded to better represent the nature of the application.

Occupancy network commands state	Front end system state text examples
Local Occupancy (PIR active)	Room rented PIR economy enabled
Occupied	Room rented high comfort assured
Unoccupied	Room not rented

Sequence of operation:

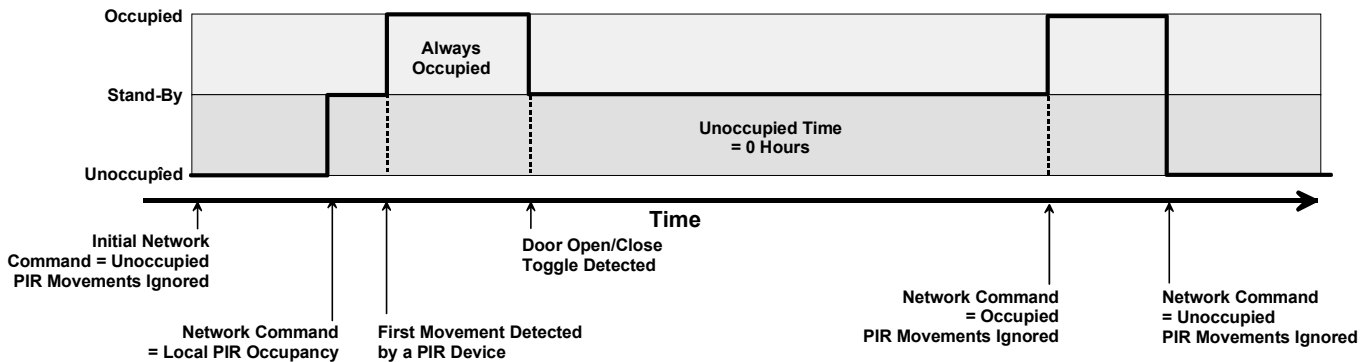

At initial power-up, when the thermostat 24 Vac power supply is applied; if there is no occupancy network command received by the thermostat and if the PIR device does not detect any movement, the initial occupancy of the zone will be stand-by mode.

Occupied state network command

At any time, an occupied network command will always force the local zone to be in occupied mode and to use the occupied setpoints.

Unoccupied state network command

At any time, an unoccupied network command will always force the local zone to be in unoccupied mode and to use the unoccupied setpoints. If the thermostat local override function is not locked out by configuration, the local user may initiate a temporary local override to occupied as dictated by the temporary occupancy time configuration parameter setting.

Local occupancy state network command

If previously in unoccupied mode when the thermostat receives a local occupancy state network command, the local PIR occupancy loop will now be enabled. If the PIR devices do not then detect any movements, the occupancy of the zone will be stand-by mode.

As soon as the PIR device detects a movement or motion, the occupancy status switches to occupied and the occupied setpoints are used. The room will then be in occupied mode until a door toggle is detected.

If a door toggle is detected, then the room switches to stand-by mode and the stand-by setpoints are used. If any occupants are left in the room, local movements must be seen to resume the occupied mode.

At anytime, if the PIR device detects a local movement or motion, the occupancy status switches to occupied and the occupied setpoints are used.

The local zone never goes into unoccupied mode and the unoccupied setpoints are never used.

3. TB7300 networked fan coil application—3 levels of occupancy with a remote PIR sensor

Set-up and Configuration	
Thermostat used	TB73x5X5014X (lodging models)
PIR used	BI1 configured for remote PIR sensor
BI2 Configuration	Door dry contact
Stand-by timer value	Not used
Unoccupied timer value	6.0 hours
Network interface used	BACnet MS/TP or wireless

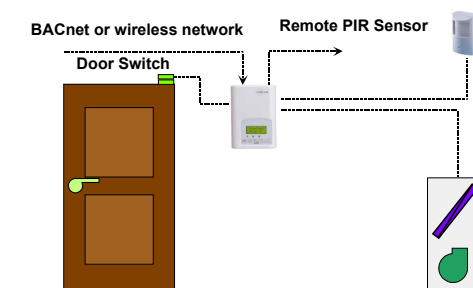

Advanced network interface can be obtained when thermostats are fully integrated to the reservation system

In these cases, the occupancy network commands state enumerations text presented by a front end system can be expanded to better represent the nature of the application.

Occupancy network commands state	Front end system state text examples
Local Occupancy (PIR active)	Room rented PIR economy enabled
Occupied	Room rented high comfort assured
Unoccupied	Room not rented

Sequence of operation

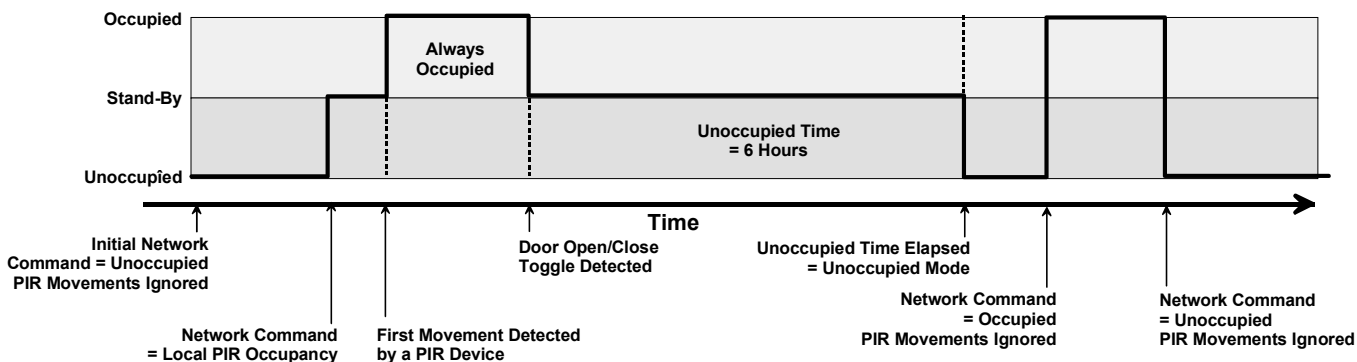

At initial power-up, when the thermostat 24 Vac power supply is applied; if there is no occupancy network command received by the thermostat and if the PIR devices do not detect any movement, the initial occupancy of the zone will be stand-by mode.

Occupied state network command

At any time, an occupied network command will always force the local zone to be in occupied mode and to use the occupied setpoints.

Unoccupied state network command

At any time, an unoccupied network command will always force the local zone to be in unoccupied mode and to use the unoccupied setpoints. If the thermostat local override function is not locked out by configuration, the local user may initiate a temporary local override to occupied as dictated by the temporary occupancy time configuration parameter setting.

Local occupancy state network command

If previously in unoccupied mode when the thermostat receives a local occupancy state network command, the local PIR occupancy loop will now be enabled. If the PIR devices do not then detect any movements, the occupancy of the zone will be stand-by mode.

As soon as the PIR device detects a movement or motion, the occupancy status switches to occupied and the occupied setpoints are used. The room will then be in occupied mode until a door toggle is detected.

If a door toggle is detected, then the room switches to stand-by mode and the stand-by setpoints are used. If any occupants are left in the room, local movements must be seen to resume the occupied mode.

While in stand-by mode, if no motion is detected in the zone for the entire unoccupied timer duration, then the room switches to unoccupied mode and the unoccupied setpoints are used.

At anytime, if the PIR device detects a local movement or motion, the occupancy status switches to occupied and the occupied setpoints are used.

4. TB7300 networked fan coil application—2 levels of occupancy with a remote PIR sensor

Set-up and Configuration	
Thermostat used	TB73x5X5014X (lodging models)
PIR used	BI1 configured for remote PIR sensor
BI2 Configuration	Door dry contact
Stand-by timer value	Not used
Unoccupied timer value	0.0 hours
Network interface used	BACnet MS/TP or wireless

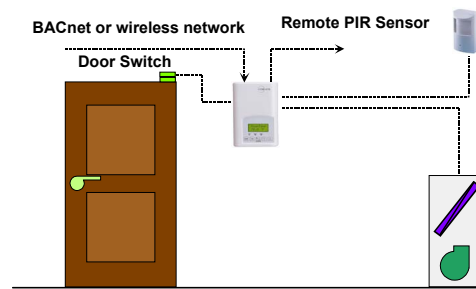

Advanced network interface can be obtained when thermostats are fully integrated to the reservation system.

In these cases, the occupancy network commands state enumerations text presented by a front end system can be expanded to better represent the nature of the application.

Occupancy network commands state	Front end system state text examples
Local Occupancy (PIR active)	Room rented PIR economy enabled
Occupied	Room rented high comfort assured
Unoccupied	Room not rented

Sequence of operation:

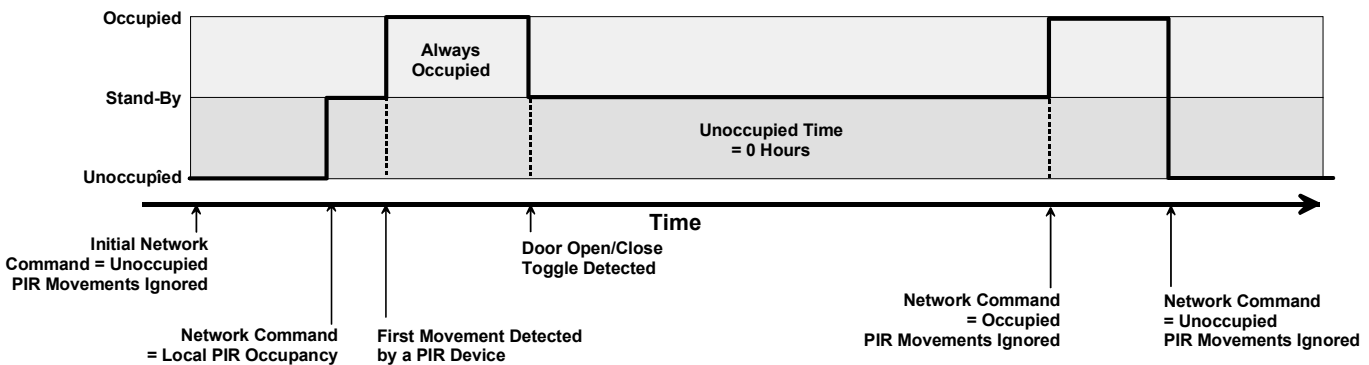

At initial power-up, when the thermostat 24 Vac power supply is applied; if there is no occupancy network command received by the thermostat and if the PIR devices do not detect any movement, the initial occupancy of the zone will be stand-by mode.

Occupied state network command

At any time, an occupied network command will always force the local zone to be in occupied mode and to use the occupied setpoints.

Unoccupied state network command

At any time, an unoccupied network command will always force the local zone to be in unoccupied mode and to use the unoccupied setpoints. If the thermostat local override function is not locked out by configuration, the local user may initiate a temporary local override to occupied as dictated by the temporary occupancy time configuration parameter setting.

Local occupancy state network command

If previously in unoccupied mode when the thermostat receives a local occupancy state network command, the local PIR occupancy loop will now be enabled. If the PIR devices do not then detect any movements, the occupancy of the zone will be stand-by mode.

As soon as the PIR device detects a movement or motion, the occupancy status switches to occupied and the occupied setpoints are used. The room will then be in occupied mode until a door toggle is detected.

If a door toggle is detected, then the room switches to stand-by mode and the stand-by setpoints are used. If any occupants are left in the room, local movements must be seen to resume the occupied mode.

At anytime, if the PIR device detects a local movement or motion, the occupancy status switches to occupied and the occupied setpoints are used.

The local zone never goes into unoccupied mode and the unoccupied setpoints are never used.

5. TB7300 networked fan coil application—3 levels of occupancy with dual PIR sensors

Set-up and Configuration	
Thermostat used	TB73x5X5014X (lodging models)
PIR used	BI1 configured for remote PIR sensor and TB-PIR-FCU-L cover
BI2 Configuration	Door dry contact
Stand-by timer value	Not used
Unoccupied timer value	6.0 hours
Network interface used	BACnet MS/TP or wireless

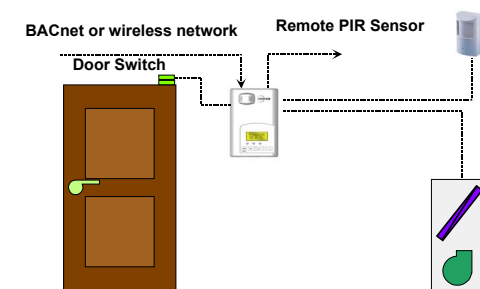

Advanced network interface can be obtained when thermostats are fully integrated to the reservation system

In these cases, the occupancy network commands state enumerations text presented by a front end system can be expanded to better represent the nature of the application.

Occupancy network commands state	Front end system state text examples
Local Occupancy (PIR active)	Room rented PIR economy enabled
Occupied	Room rented high comfort assured
Unoccupied	Room not rented

Sequence of operation:

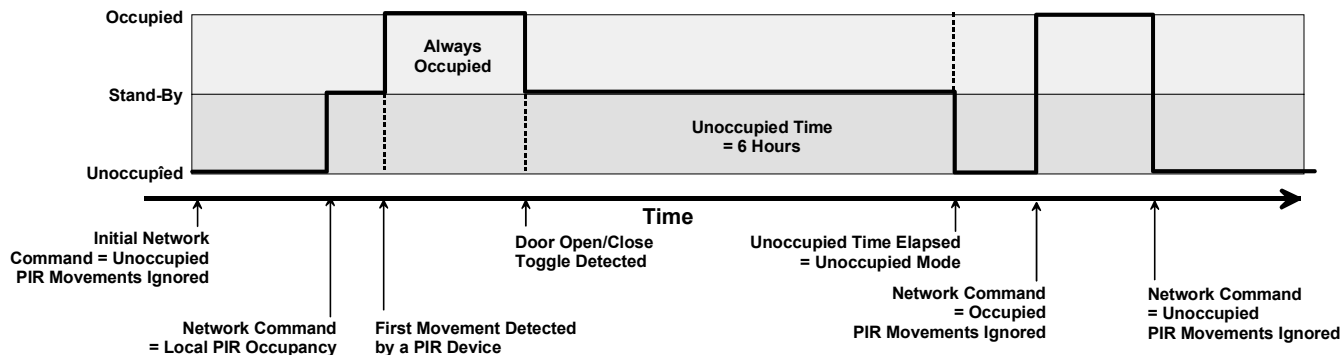

At initial power-up, when the thermostat 24 Vac power supply is applied; if there is no occupancy network command received by the thermostat and if the PIR devices do not detect any movement, the initial occupancy of the zone will be stand-by mode.

Occupied state network command

At any time, an occupied network command will always force the local zone to be in occupied mode and to use the occupied setpoints.

Unoccupied state network command

At any time, an unoccupied network command will always force the local zone to be in unoccupied mode and to use the unoccupied setpoints. If the thermostat local override function is not locked out by configuration, the local user may initiate a temporary local override to occupied as dictated by the temporary occupancy time configuration parameter setting.

Local occupancy state network command

If previously in unoccupied mode when the thermostat receives a local occupancy state network command, the local PIR occupancy loop will now be enabled. If the PIR devices do not then detect any movements, the occupancy of the zone will be stand-by mode.

As soon as the PIR device detects a movement or motion, the occupancy status switches to occupied and the occupied setpoints are used. The room will then be in occupied mode until a door toggle is detected.

If a door toggle is detected, then the room switches to stand-by mode and the stand-by setpoints are used. If any occupants are left in the room, local movements must be seen to resume the occupied mode.

While in stand-by mode, if no motion is detected in the zone for the entire unoccupied timer duration, then the room switches to unoccupied mode and the unoccupied setpoints are used.

At anytime, if the PIR device detects a local movement or motion, the occupancy status switches to occupied and the occupied setpoints are used.

6. TB7300 networked fan coil application—2 levels of occupancy with dual PIR sensors

Set-up and Configuration	
Thermostat used	TB73x5X5014X (lodging models)
PIR used	BI1 configured for remote PIR sensor and TB-PIR-FCU-L cover
BI2 Configuration	Door dry contact
Stand-by timer value	Not used
Unoccupied timer value	0.0 hours
Network interface used	BACnet MS/TP or wireless

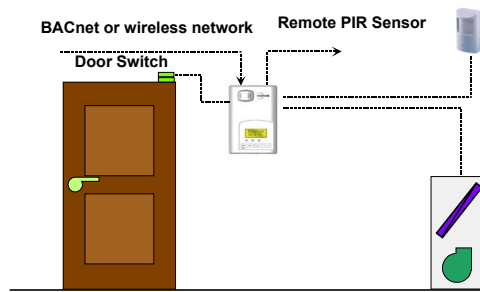

Advanced network interface can be obtained when thermostats are fully integrated to the reservation system.

In these cases, the occupancy network commands state enumerations text presented by a front end system can be expanded to better represent the nature of the application.

Occupancy network commands state	Front end system state text examples
Local Occupancy (PIR active)	Room rented PIR economy enabled
Occupied	Room rented high comfort assured
Unoccupied	Room not rented

Sequence of operation

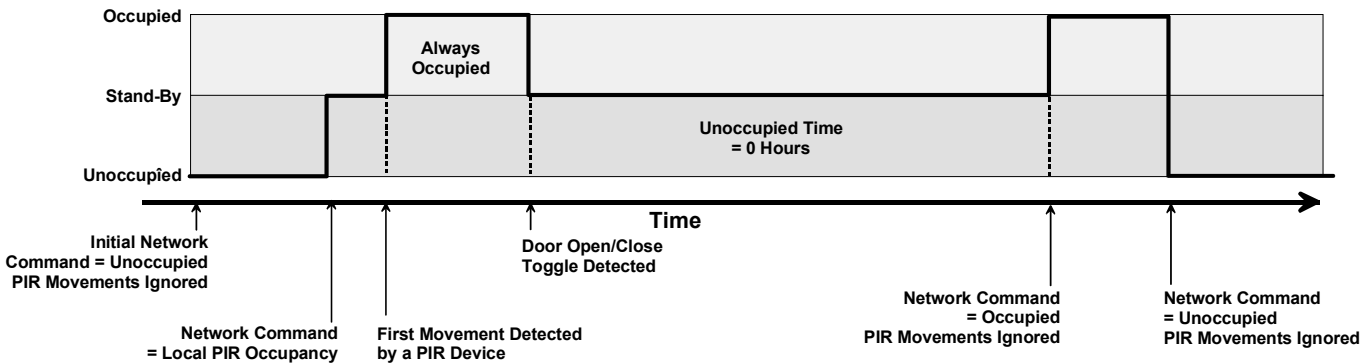

At initial power-up, when the thermostat 24 Vac power supply is applied; if there is no occupancy network command received by the thermostat and if the PIR devices do not detect any movement, the initial occupancy of the zone will be stand-by mode.

Occupied state network command

At any time, an occupied network command will always force the local zone to be in occupied mode and to use the occupied setpoints.

Unoccupied state network command

At any time, an unoccupied network command will always force the local zone to be in unoccupied mode and to use the unoccupied setpoints. If the thermostat local override function is not locked out by configuration, the local user may initiate a temporary local override to occupied as dictated by the temporary occupancy time configuration parameter setting.

Local occupancy state network command

If previously in unoccupied mode when the thermostat receives a local occupancy state network command, the local PIR occupancy loop will now be enabled. If the PIR devices do not then detect any movements, the occupancy of the zone will be stand-by mode.

As soon as the PIR device detects a movement or motion, the occupancy status switches to occupied and the occupied setpoints are used. The room will then be in occupied mode until a door toggle is detected.

If a door toggle is detected, then the room switches to stand-by mode and the stand-by setpoints are used. If any occupants are left in the room, local movements must be seen to resume the occupied mode.

At anytime, if the PIR device detects a local movement or motion, the occupancy status switches to occupied and the occupied setpoints are used.

The local zone never goes into unoccupied mode and the unoccupied setpoints are never used.

7. TB7300 stand-alone fan coil application—3 levels of occupancy with an occupancy sensor cover

Set-up and Configuration	
Thermostat used	TB73x0X5014X (lodging models)
PIR used	TB-PIR-FCU-L cover
BI2 Configuration	Door dry contact
Stand-by timer value	Not used
Unoccupied timer value	6.0 hours
Network interface used	None, stand-alone

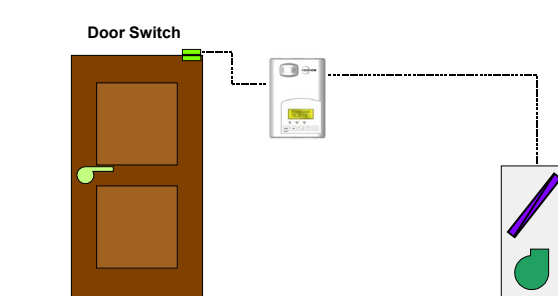

Sequence of operation:

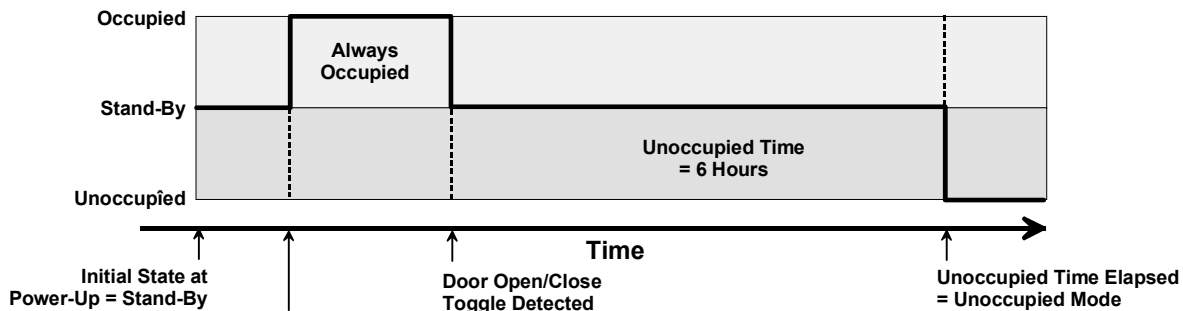

At initial power-up, when the thermostat 24 Vac power supply is applied; the initial occupancy of the zone will be stand-by mode if the PIR device does not detect any movement.

As soon as the PIR device detects a movement or motion, the occupancy status switches to occupied and the occupied setpoints are used. The room will then be in occupied mode until a door toggle is detected.

If a door toggle is detected, then the room switches to stand-by mode and the stand-by setpoints are used. If any occupants are left in the room, local movements must be seen to resume the occupied mode.

While in stand-by mode, if no motion is detected in the zone for the entire unoccupied timer duration, then the room switches to unoccupied mode and the unoccupied setpoints are used.

At anytime, if the PIR device detects a local movement or motion, the occupancy status switches to occupied and the occupied setpoints are used.

8. TB7300 stand-alone fan coil application—2 levels of occupancy with an occupancy sensor cover

Set-up and Configuration	
Thermostat used	TB73x0X5014X (lodging models)
PIR used	TB-PIR-FCU-L cover
BI2 Configuration	Door dry contact
Stand-by timer value	Not used
Unoccupied timer value	0.0 hours
Network interface used	None, stand-alone

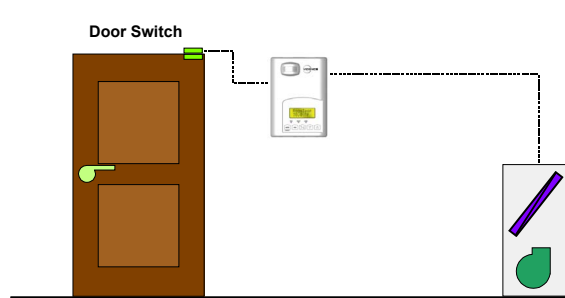

Sequence of operation:

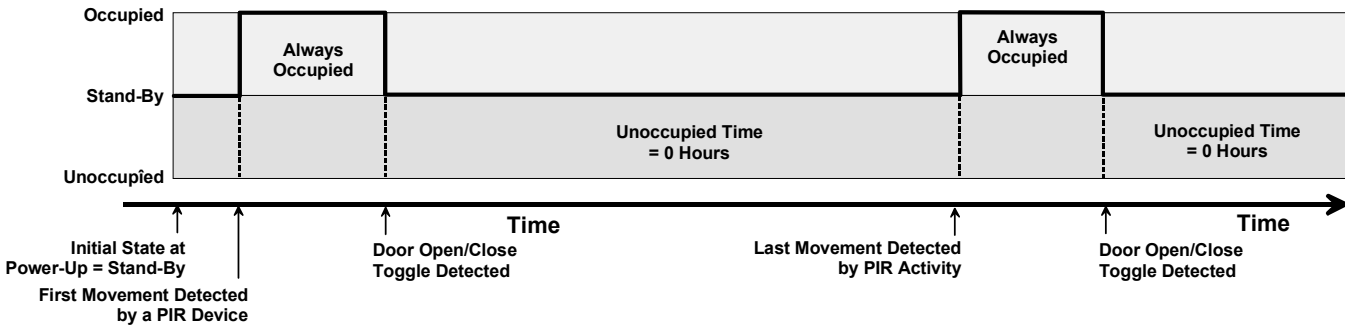

At initial power-up, when the thermostat 24 Vac power supply is applied; the initial occupancy of the zone will be stand-by mode if the PIR device does not detect any movement.

As soon as the PIR device detects a movement or motion, the occupancy status switches to occupied and the occupied setpoints are used. The room will then be in occupied mode until a door toggle is detected.

If a door toggle is detected, then the room switches to stand-by mode and the stand-by setpoints are used. If any occupants are left in the room, local movements must be seen to resume the occupied mode.

At anytime, if the PIR device detects a local movement or motion, the occupancy status switches to occupied and the occupied setpoints are used.

The local zone never goes into unoccupied mode and the unoccupied setpoints are never used.

9. TB7300 stand-alone fan coil application—3 levels of occupancy with a remote PIR sensor

Set-up and Configuration	
Thermostat used	TB73x0X5014X (lodging models)
PIR used	BI1 configured for remote PIR sensor
BI2 Configuration	Door dry contact
Stand-by timer value	Not used
Unoccupied timer value	6.0 hours
Network interface used	None, stand-alone

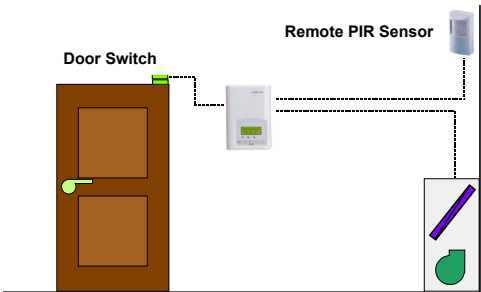

Sequence of operation:

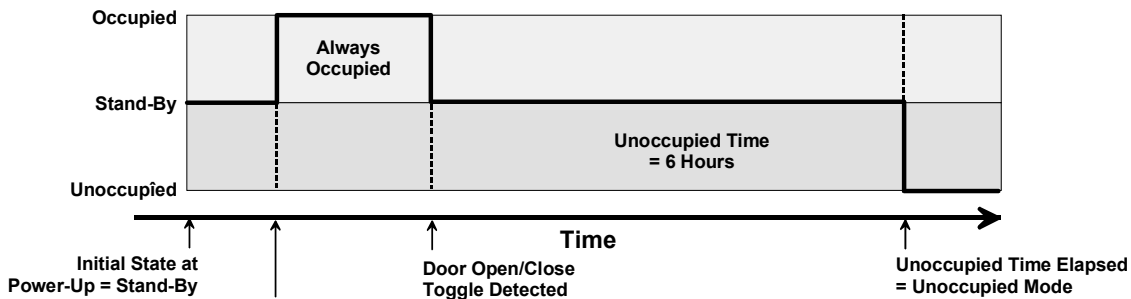

At initial power-up, when the thermostat 24 Vac power supply is applied; the initial occupancy of the zone will be stand-by mode if the PIR device does not detect any movement.

As soon as the PIR device detects a movement or motion, the occupancy status switches to occupied and the occupied setpoints are used. The room will then be in occupied mode until a door toggle is detected.

If a door toggle is detected, then the room switches to stand-by mode and the stand-by setpoints are used. If any occupants are left in the room, local movements must be seen to resume the occupied mode.

While in stand-by mode, if no motion is detected in the zone for the entire unoccupied timer duration, then the room switches to unoccupied mode and the unoccupied setpoints are used.

At anytime, if the PIR device detects a local movement or motion, the occupancy status switches to occupied and the occupied setpoints are used.

10. TB7300 stand-alone fan coil application—2 levels of occupancy with a remote PIR sensor

Set-up and Configuration	
Thermostat used	TB73x5X5014X (lodging models)
PIR used	BI1 configured for remote PIR sensor
BI2 Configuration	Door dry contact
Stand-by timer value	Not used
Unoccupied timer value	0.0 hours
Network interface used	None, stand-alone

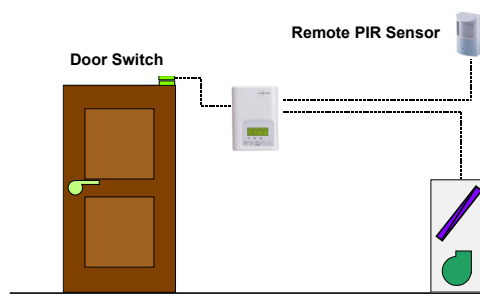

Sequence of operation:

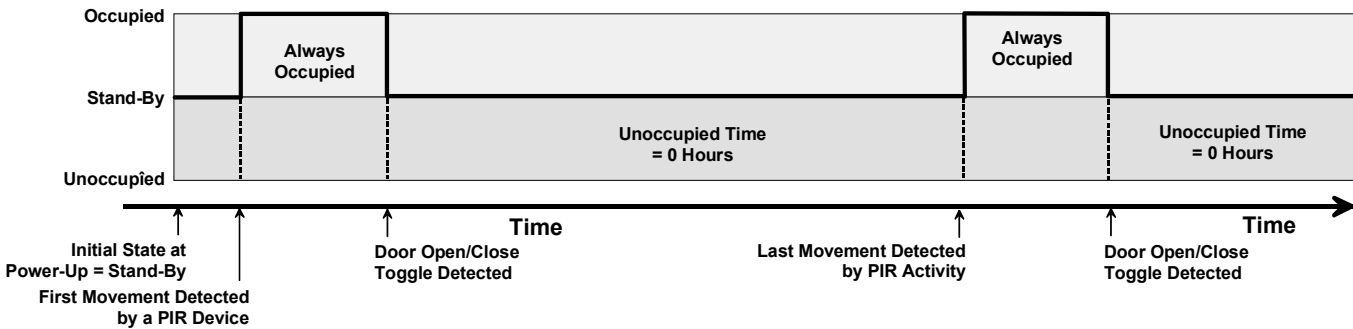

At initial power-up, when the thermostat 24 Vac power supply is applied; the initial occupancy of the zone will be stand-by mode if the PIR device does not detect any movement.

As soon as the PIR device detects a movement or motion, the occupancy status switches to occupied and the occupied setpoints are used. The room will then be in occupied mode until a door toggle is detected.

If a door toggle is detected, then the room switches to stand-by mode and the stand-by setpoints are used. If any occupants are left in the room, local movements must be seen to resume the occupied mode.

At anytime, if the PIR device detects a local movement or motion, the occupancy status switches to occupied and the occupied setpoints are used.

The local zone never goes into unoccupied mode and the unoccupied setpoints are never used.

11. TB7300 stand-alone fan coil application—3 levels of occupancy with dual PIR sensors

Set-up and Configuration	
Thermostat used	TB73x5X5014X (lodging models)
PIR used	BI1 configured for remote PIR sensor and TB-PIR-FCU-L cover
BI2 Configuration	Door dry contact
Stand-by timer value	2.0 hours
Unoccupied timer value	6.0 hours
Network interface used	None, stand-alone

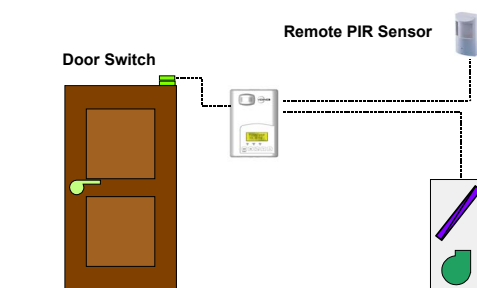

Sequence of operation:

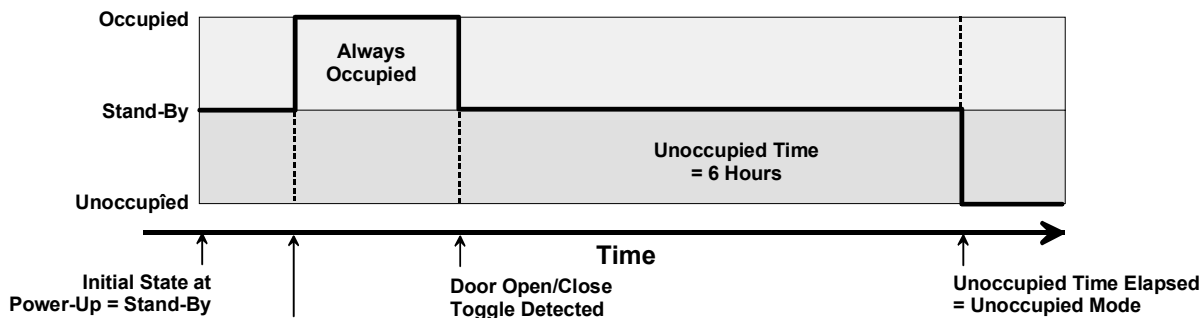

At initial power-up, when the thermostat 24 Vac power supply is applied; the initial occupancy of the zone will be stand-by mode if the PIR devices do not detect any movement.

As soon as a PIR device detects a movement or motion, the occupancy status switches to occupied and the occupied setpoints are used. The room will then be in occupied mode until a door toggle is detected.

If a door toggle is detected, then the room switches to stand-by mode and the stand-by setpoints are used. If any occupants are left in the room, local movements must be seen to resume the occupied mode.

While in stand-by mode, if no motion is detected in the zone for the entire unoccupied timer duration, then the room switches to unoccupied mode and the unoccupied setpoints are used.

At anytime, if the PIR device detects a local movement or motion, the occupancy status switches to occupied and the occupied setpoints are used.

12. TB7300 stand-alone fan coil application—2 levels of occupancy with dual PIR sensors

Set-up and Configuration	
Thermostat used	TB73x5X5014X (lodging models)
PIR used	BI1 configured for remote PIR sensor and TB-PIR-FCU-L cover
BI2 Configuration	Door dry contact
Stand-by timer value	Not used
Unoccupied timer value	0.0 hours
Network interface used	None, stand-alone

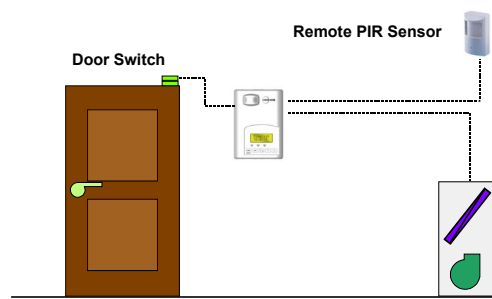

Sequence of operation:

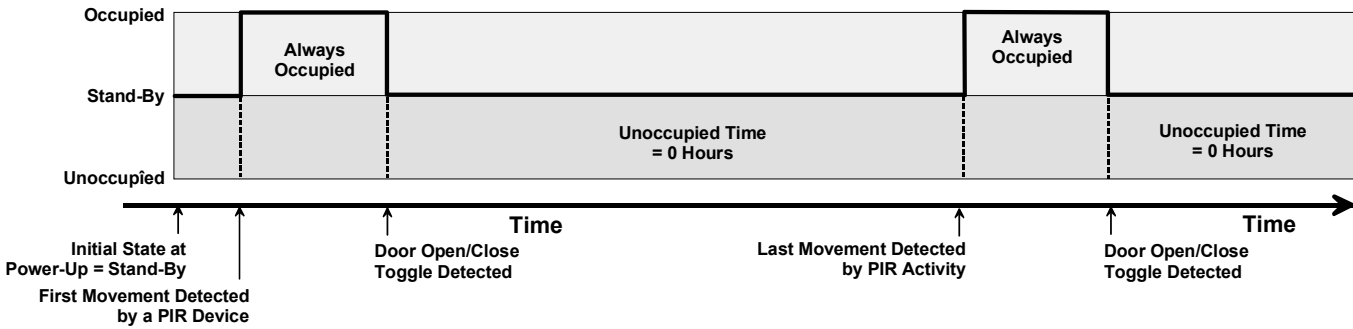

At initial power-up, when the thermostat 24 Vac power supply is applied; the initial occupancy of the zone will be stand-by mode if the PIR devices do not detect any movement.

As soon as a PIR device detects a movement or motion, the occupancy status switches to occupied and the occupied setpoints are used. The room will then be in occupied mode until a door toggle is detected.

If a door toggle is detected, then the room switches to stand-by mode and the stand-by setpoints are used. If any occupants are left in the room, local movements must be seen to resume the occupied mode.

At anytime, if a PIR device detects a local movement or motion, the occupancy status switches to occupied and the occupied setpoints are used.

The local zone never goes into unoccupied mode and the unoccupied setpoints are never used.

Typical PIR Detection Pattern

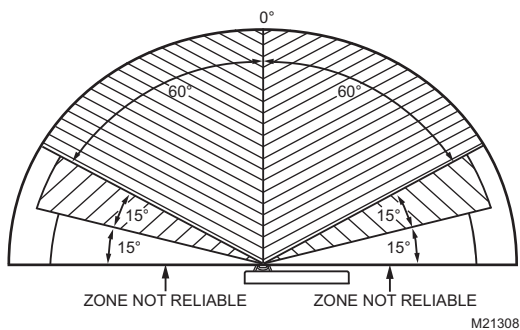

Fig. 3. Typical Horizontal Angle

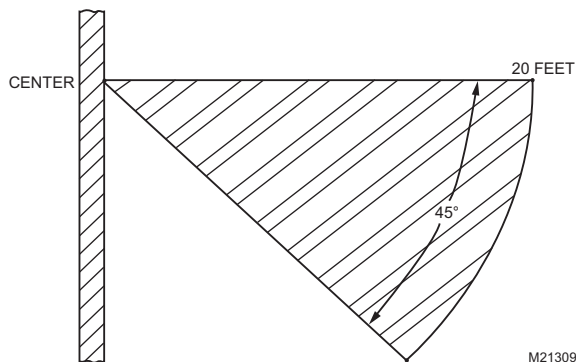

Fig. 4. Typical Vertical Angle

INSTALLATION

WARNING

Electronic controls are static sensitive devices. Discharge yourself properly before manipulation and installing the thermostat and its accessories.

Short circuit or wrong wiring may permanently damage the thermostat or the equipment. All TB7200 and 7300 Series thermostats are to be used only as operating controls. Whenever a control failure could lead to personal injury and/or loss of property, it becomes the responsibility of the user to add safety devices and/or alarm system to protect against such catastrophic failures.

Table 2. Installation Tips

Tip Type	Area Of Interest	Explanation
General Installation	PIR Connector	Polarized connector is located at bottom left hand corner of TB7200 or TB7300 Series thermostat
	Security Screw	A security screw has been provided in the thermostat box. This screw should be carefully installed in the intended mounting position located bottom center of thermostat cover.
Initial Power Up & Commissioning	PIR Warm up period	PIR Sensor may take up-to 60 seconds after initial warm up period to detect movement consistent with typical detection pattern.
	Visual indication (Status of PIR)	Visual indication of PIR activity for commissioning is provided via a blinking LEDs located on the thermostat cover under the PIR lens. LEDs will be active while occupant is in field of detection pattern for a period of 30 minutes after initial power up.

TB-PIR Cover Installation

1. Remove security screw on the bottom of the thermostat cover.
2. Open up by pulling on the bottom side of thermostat. (Fig. 3)

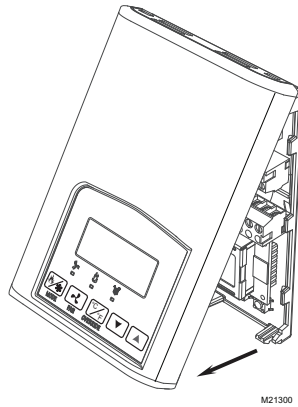

Fig. 5. Removing cover.

3. Insert polarized connector from new cover into PIR female connector located on thermostat base. (Fig. 6)



Fig. 6. PIR connector

4. Snap PIR thermostat cover into place and re-install the security screw. (Fig. 7)
5. Make appropriate parameter settings related to your application within the configuration menu or through the WEBStation-AX as identified in the thermostat installation instructions.



Fig. 7. Replacing cover.

PIR Status LED's

The PIR covers have 2 green status LEDs behind the PIR lens that can be used for diagnostic purposes during commissioning or servicing. (Fig. 8)

These LEDs are used to indicate a local movement detected by the PIR cover.

- The status LEDs start to function to indicate movement 1 minute after the initial power up of the thermostat.
- The status LEDs will only remain active to indicate sensed movement 30 minutes after the initial power up of the thermostat.

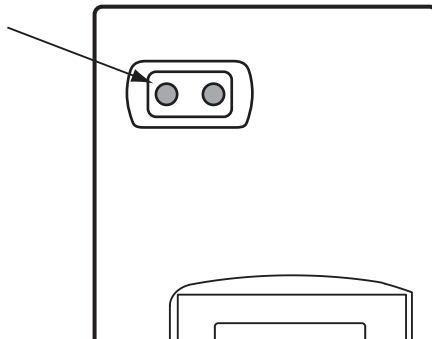

Fig. 8. LED status lights.

SPECIFICATIONS

PIR cover power requirements: 5 Vdc max current draw of 7mA

Operating conditions: 0 C to 50 C (32 F to 122 F); 0% to 95% R.H. non-condensing

Storage conditions: -30 C to 50 C (-22 F to 122 F); 0% to 95% R.H. non-condensing

Sensor: Local Passive Infrared Sensor

Dimensions: 4.94 in. x 3.38 in. x 1.0 in.

Approximate shipping weight: 0.1 lb

Agency Approvals:

UL: UL 873 (US) and **CSA** C22.2 No. 24 (Canada), File E27734 with CCN XAPX (US) and XAPX7 (Canada)

FCC: Compliant to CFR 47, Part 15, Subpart B, Class A (US)

Industry Canada: ICES-003 (Canada)

CE: EMC Directive 89/336/EEC (Europe Union)

Automation and Control Solutions

Honeywell International Inc.
1985 Douglas Drive North
Golden Valley, MN 55422

Honeywell Limited-Honeywell Limitée
35 Dynamic Drive
Toronto, Ontario M1V 4Z9
customer.honeywell.com

® U.S. Registered Trademark
© 2011 Honeywell International Inc.
63-4526-01 M.S. 06-11
Printed in U.S.A.

Honeywell